

# Orthopaedic product range guide



**Delta-Cast<sup>®</sup>**

**Actimove<sup>®</sup>**

 **essity**

Our wide range of therapeutic solutions, clinical expertise and world-class brands **mean one partner to support your needs.**

- Wound Care: **Leukoplast®** **Cutimed®**
- Orthopedics: **Actimove®** **Delta-Cast®**
- Compression: **JOBST®**



## Your advantage

**Wide range of therapeutic solutions means one partner to support your needs.**

### The value of higher quality products

- Do more with less
- Lower overall costs
- Improve patient outcomes

### Clinical Expertise

- Strong clinical in-servicing through nurses, field staff, advisory and web-guides.
- Keep current with clinical training and webinars

### Innovative Solutions

- Proven product solutions you can count on to help you better manage medical conditions.

## Our goal

**Being your ally in better outcomes for you and those in your care.  
Now and for the future.**

## Contents

<b>Non-invasive fracture treatment pathway</b>	6	<b>Tapes and Bandages</b>	
<b>Primary Immobilisation</b>		Leukoplast® Standard	36
Dynacast® Prelude	7	Leukoplast® Elastic	36
Gypsona®	8	Easifix® Cohesive	37
Gypsona® Extra 3	9	Handy®Gauze Cohesive	37
Specialist®	10	Elastolite®	38
Tensoplast® Skin Traction Kit	11	Tensogrip®	38
<b>Secondary Immobilisation</b>			
Delta-Lite® Plus	14		
Delta-Cast® Elite	15		
Delta-Cast® Prints	16		
Delta-Cast® Soft	17		
<b>Undercast Materials</b>			
Soffbar® Natural	20		
Soffbar® Synthetic	21		
Artiflex® Soft	22		
Velband™	23		
AquaCast® Liner	24		
Delta-Dry®	25		
Protouch® Stockinette	26		
Delta Terry-Net™ S	27		
<b>Cast Removal Equipment</b>			
Delta-Cast® Serene	30		
deSoutter Cast Saw CC4	31		
deSoutter Cast Saw CC7	32		
deSoutter Battery Powered Saw – CSB-100	33		
deSoutter Battery/Mains Powered Saw CSP-201	34		
Cast Room Accessories	35		

**Please Note:** Not all products available in New Zealand

# Primary Immobilisation

The conservative management of soft tissue injuries, fractures and orthopaedic conditions requires a broad range of high-quality, clinically effective products that are easy to use, cost-effective and maintain patient quality of life.

This range provides an all-encompassing portfolio to meet the treatment needs of patients requiring primary and/or secondary immobilisation through to post-healing rehabilitation.

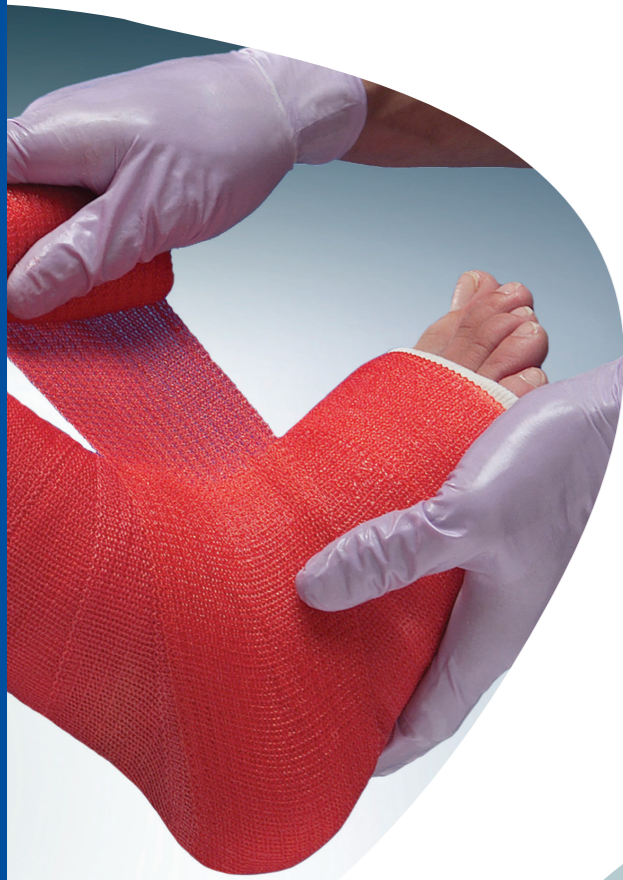

## Casting and Splinting Workshops

Essity has an ongoing commitment to educational support for clinicians involved in the provision of casting and splinting services in the healthcare environment. Training is offered in the form of in-services or educational workshops (with hands-on activity) to ensure all clinicians understand the appropriate and cost effective use of our products.

There is also a range of educational resources including application posters, instructional videos, application manuals and usage guides to assist in treatment management.

**If you would like more detailed information about the education services on offer, please contact Essity Customer Service on 1300 276 633.**



# Non-invasive fracture treatment pathway

Treatment Pathway	Objective	Considerations	Product Options
<b>Primary Immobilisation</b>	<ul style="list-style-type: none"> <li>Reduce and stabilise fracture</li> <li>Manage soft tissue injury</li> <li>Reduce oedema</li> </ul>	<ul style="list-style-type: none"> <li>Pain</li> <li>Oedema</li> <li>Fracture stability</li> <li>Wound management</li> </ul>	<ul style="list-style-type: none"> <li>Gypsona®</li> <li>Gypsona® Extra 3</li> <li>Specialist®</li> <li>Dynacast® Prelude</li> <li>Tensoplast® Traction Kits</li> <li>Actimove® Supports</li> <li>Elastolite®</li> <li>Easifix® / Handy® Gauze Cohesive</li> </ul>
<b>Secondary Immobilisation</b>	<ul style="list-style-type: none"> <li>Maintain alignment</li> <li>Achieve union</li> <li>Promote bone growth</li> </ul>	<ul style="list-style-type: none"> <li>Muscle atrophy</li> <li>Skin deterioration</li> <li>Non/mal union</li> <li>Joint stiffness</li> <li>Wound management</li> </ul>	<ul style="list-style-type: none"> <li>Delta-Lite® Plus</li> <li>Delta-Cast® Elite</li> <li>Delta-Cast® Prints</li> <li>Delta-Cast® Soft</li> <li>Actimove® Supports</li> </ul>
<b>Supra and Sub Cast Protection</b>	<ul style="list-style-type: none"> <li>Protect limb/soft tissue</li> <li>Protect cast</li> <li>Position limb</li> </ul>	<ul style="list-style-type: none"> <li>Skin sensitivity</li> <li>Maceration</li> <li>Pressure sores</li> <li>Smell</li> <li>Cast breakdown</li> </ul>	<ul style="list-style-type: none"> <li>Soffban® Natural</li> <li>Soffban® Synthetic</li> <li>Artiflex® Soft</li> <li>Velband™</li> <li>AquaCast® Liner</li> <li>Delta-Dry®</li> <li>Protouch® Stockinette</li> <li>Delta Terry-Net™ S</li> <li>Actimove® Cast Shoe</li> </ul>
<b>Cast Removal</b>	<ul style="list-style-type: none"> <li>Remove cast quickly and safely</li> </ul>	<ul style="list-style-type: none"> <li>Saw and dust inhalation</li> <li>Heat build up</li> </ul>	<ul style="list-style-type: none"> <li>Deltacast® Serene</li> <li>deSoutter Cast Saws</li> <li>Cast Shears and Spreaders</li> </ul>
<b>Post Healing Rehabilitation</b>	<ul style="list-style-type: none"> <li>Protect injury site</li> <li>Regain strength and mobility</li> </ul>	<ul style="list-style-type: none"> <li>Protect injury site</li> <li>Regain strength and mobility</li> </ul>	<ul style="list-style-type: none"> <li>Actimove® Genu Eco</li> <li>Actimove® Genu Tri-Panel</li> <li>Actimove® Lower Leg Walker</li> <li>Actimove® Umerus Comfort</li> <li>Actimove® Umerus</li> <li>Actimove® Mitella Comfort</li> <li>Actimove® Mitella</li> <li>Actimove® Mitella Arm Sling</li> <li>Actimove® Mitella for Kids</li> <li>Actimove® Sling</li> <li>Actimove® Sling for Kids</li> <li>Actimove® Manus Air</li> <li>Actimove® TaloMotion</li> <li>Actimove® Genu Motion</li> <li>Actimove® ManuMotion</li> <li>Actimove® Manus Forte</li> <li>Actimove® Manus Forte Plus</li> <li>Actimove® EpiMotion</li> <li>Actimove® Cervical</li> <li>Actimove® Rhizo Forte</li> <li>Actimove® Solea</li> <li>Actimove® Post-Op ROM Knee Brace</li> <li>Actimove® Shoulder Abduction Sling</li> </ul>

## Dynacast® Prelude Acute Synthetic Splinting System



- All in one system
- High conformability
- Easy moulding
- Smooth splint surface
- Easy to cut
- Lightweight

Dynacast® Prelude is an acute synthetic splinting system combining polyurethane coated fibreglass and polypropylene padding. Dynacast® Prelude comes pre-assembled and ready to use, giving a cost effective splinting alternative to traditional ways of providing support and immobilisation.

### Single layer knit design

Dynacast® Prelude is constructed using an innovative 3D knitting process, which produces a single interlocking knit layer construction. This construction ensures high conformability to the limb, optimum splint smoothness and increased patient comfort throughout the term of the treatment.

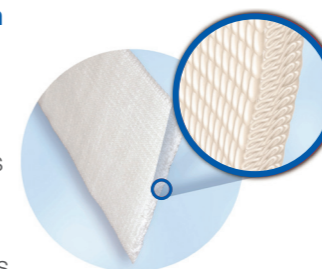

### Indications

- Primary immobilisation of acute fractures and soft tissue injuries

### Ordering information

Ref. No.	Size	Items per Unit
<b>Roll Presentation</b>		
71418-00	2.5cm x 4.6m	1 roll
71420-00	5cm x 4.6m	1 roll
71421-00	7.5cm x 4.6m	1 roll
71415-00	10cm x 4.6m	1 roll
71416-00	12.5cm x 4.6m	1 roll
71417-00	15cm x 4.6m	1 roll
71419-00	20cm x 2.6m	1 roll
<b>Pre-Cut Lengths</b>		
72869-00	5cm x 25cm	bx/5
47222-00	7.5cm x 30cm	bx/5
47225-00	10cm x 40cm	bx/5
47226-00	10cm x 76cm	bx/4
47235-00	12.5cm x 76cm	bx/4
<b>Fiskars Scissors</b>		
72046-10	Fiskars Scissors	bx/1

# Gypsona®

## Plaster of Paris Bandage



- Fast immobilisation of fractures
- Leno cloth for good conformability and stability
- Rich creamy texture
- Low plaster loss
- Moisture resistant packaging

Gypsona® Plaster of Paris (POP) bandages are made from a leno cloth, uniformly impregnated with a high quality fast setting Plaster of Paris, which has a rich creamy texture for easy handling. The interlocked weave of the leno cloth makes the wet bandages stable, conformable and easy to mould and minimises plaster loss.

### Benefits

Gypsona® retains the Plaster of Paris on the cloth so plaster loss is at a minimum whilst soaking and when being moulded. The cloth permits Gypsona® to be accurately and easily moulded to give a smooth inside surface and uniform thickness. Gypsona® will set and harden quickly to give strong immobilisation for trauma and corrective work.

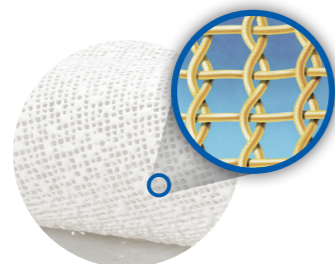

### Indications

- For external splinting of fractures
- Immobilisation of diseased bones and joints
- Correction of deformities
- Emergency splinting
- Making negative and positive casts

### Ordering information

Ref. No.	Size	Items per Unit
<b>Gypsona® B.P. Plaster Bandages</b>		
71987-51	5cm x 2.75m	12 rolls/bx
71987-54	7.5cm x 3.5m	24 rolls/bx
71987-40	10cm x 3.5m	24 rolls/bx
71987-45	15cm x 3.5m	12 rolls/bx
71987-50	20cm x 3.5m	12 rolls/bx
<b>Gypsona® Slab Dispenser - 5 Ply</b>		
71988-21	10cm x 20m	1 roll
71988-22	15cm x 20m	1 roll
71988-23	20cm x 20m	1 roll

# Gypsona® Extra 3

## Plaster of Paris Bandage



- Leno weave gauze for good conformability and stability
- Rich creamy texture
- Low plaster loss
- Moisture resistant packaging
- Rapid immobilisation of fractures

Gypsona® Extra 3 Plaster of Paris (POP) bandages are made from a leno weave gauze, uniformly impregnated with a high quality fast setting Plaster of Paris, which has a rich creamy texture for easy handling. The interlocked weave of the leno gauze makes the wet bandages stable, conformable and easy to mould as well as minimising plaster loss.

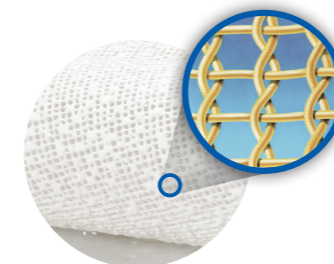

### Indications

- External splinting of fractures
- Immobilisation of diseased bones and joints
- Correction of deformities
- Emergency splinting
- Making negative and positive casts

### Ordering information

Ref. No.	Size	Items per Unit
65072-00	7.5cm x 3.5m	24 rolls/bx
65072-01	10cm x 3.5m	24 rolls/bx
65072-02	15cm x 3.5m	12 rolls/bx
75072-03	20cm x 3.5m	12 rolls/bx

# Specialist®

## Plaster of Paris Bandage



- Excellent strength
- Extra fast setting
- Low plaster loss

Specialist® Plaster of Paris uses a time-tested formula and manufacturing process to produce a consistent plaster that is uniformly coated and firmly adhered to the gauze. The result is a plaster with high dry/wet plaster retention. This means that more plaster is applied to the cast and not wasted in the wrapper or dip bucket. Specialist® casts have early green strength thus reducing the time that the cast is vulnerable to distortion

### Benefits

**Traditional dry formula** feel and easy to use characteristics of traditional plaster.

**Consistency** Eliminates the need to adjust the application technique. No variation in quality from roll-to-roll.

**High wet/dry plaster retention** More plaster on the roll.

**Early high green strength** Minimises the period when casts may be vulnerable to distortion.

**Strength** Provides casts that are ideal for a wide range of applications.



### Indications

- Fracture management
- Podiatry
- Talipes Equinovarus

### Ordering information

Ref. No.	Size	Items per Unit
72258-00	7.5cm x 4.5m	12 rolls/bx
72258-01	10cm x 4.5m	12 rolls/bx
72258-02	15cm x 4.5m	12 rolls/bx
72258-03	20cm x 4.5m	12 rolls/bx

# Tensoplast® Skin Traction Kit

## Adhesive and Non-Adhesive Skin Traction Kits



### Low Allergy, Adhesive Skin Traction Kit

- Low allergy adhesive
- Excellent conformability for easy application
- Reliable and secure
- Compression bandage for extra security

### Non-Adhesive Skin Traction Kit

- High performance elastic bandage for extra security
- Good skin friction characteristics
- High conformability for easy application



### Indications

- Abrasions or skin lacerations
- Impairment of circulation
- Traction weight greater than that which can be applied through the skin

### Ordering information

Ref. No.	Size	Items per Unit
71544-04	Adhesive (Adult)	bx/1
71554-03	Adhesive (Child)	bx/1
71555-05	Non-Adhesive (Adult)	bx/1
71556-05	Non-Adhesive (Child)	bx/1

# Secondary Immobilisation



# Delta-Lite® Plus

## Fibreglass Casting Bandage

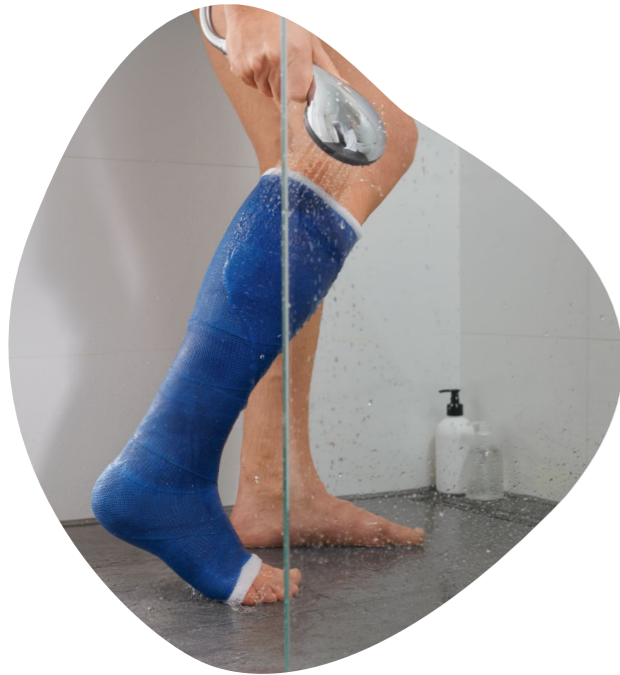

### Ordering information

Ref No.	Size	Colour	Pack Qty
73458-00	2.5cm x 1.8m roll	○ White	1 x 10
73458-01	5cm x 3.6m roll	○ White	1 x 10
73458-02	7.5cm x 3.6m roll	○ White	1 x 10
73458-03	10cm x 3.6m roll	○ White	1 x 10
73458-04	12.5cm x 3.6m roll	○ White	1 x 10
73458-55	5cm x 3.6m roll	● Pink	1 x 10
73458-56	7.5cm x 3.6m roll	● Pink	1 x 10
73458-57	10cm x 3.6m roll	● Pink	1 x 10
73458-20	5cm x 3.6m roll	● Dark blue	1 x 10
73458-21	7.5cm x 3.6m roll	● Dark blue	1 x 10
73458-22	10cm x 3.6m roll	● Dark blue	1 x 10
73458-30	5cm x 3.6m roll	● Red	1 x 10
73458-31	7.5cm x 3.6m roll	● Red	1 x 10
73458-32	10cm x 3.6m roll	● Red	1 x 10
73458-60	5cm x 3.6m roll	● Purple	1 x 10
73458-61	7.5cm x 3.6m roll	● Purple	1 x 10
73458-62	10cm x 3.6m roll	● Purple	1 x 10
73458-45	5cm x 3.6m roll	● Black	1 x 10
73458-46	7.5cm x 3.6m roll	● Black	1 x 10
73458-47	10cm x 3.6m roll	● Black	1 x 10
73458-25	5cm x 3.6m roll	● Green	1 x 10
73458-26	7.5cm x 3.6m roll	● Green	1 x 10
73458-27	10cm x 3.6m roll	● Green	1 x 10
73458-50	5cm x 3.6m roll	Mixed*	1 x 10
73458-51	7.5cm x 3.6m roll	Mixed*	1 x 10
73458-52	10cm x 3.6m roll	Mixed*	1 x 10

\* Mixed pack: Contains 2 Deep Blue, 2 Light Blue, 2 Purple, 2 Deep Red, 2 Pink. Colors and availability subject to change. Please refer to the product label and/or package insert for full instructions on the safe use of these products.

- Greater conformability
- Easy to apply
- High lamination

Delta-Lite® Plus is a fibreglass cast tape that combines a fibreglass substrate and advanced water activated polyurethane resin system which provides tack free properties. The tack free properties allow ease of application and moulding, using standard examination gloves.

#### Easy to Apply

The resin formulation has improved the unrolling tension of the bandage, making it easier to apply the cast, using standard examination gloves.

#### Greater Conformability

The heat treated substrate of Delta-Lite® Plus improves the conformability, providing greater moulding capabilities for rigid primary and secondary casting applications.

#### High Lamination

The resin system also ensures maximum lamination and end laydown, resulting in a smooth finished cast which is strong, long lasting and lightweight.

#### Indications

- Primary immobilisation of acute fractures and soft tissue injuries

# Delta-Cast® Elite

## Polyester Casting Bandage



### Ordering information

Code	Size	Colour	Pack Qty
72279-00	5cm x 3.6m roll	○ White	1 x 10
72279-01	7.5cm x 3.6m roll	○ White	1 x 10
72279-02	10cm x 3.6m roll	○ White	1 x 10
72279-03	12.5cm x 3.6m roll	○ White	1 x 10
72278-00	5cm x 3.6m roll	● Black	1 x 10
72278-01	7.5cm x 3.6m roll	● Black	1 x 10
72278-02	10cm x 3.6m roll	● Black	1 x 10
72276-00	5cm x 3.6m roll	● Dark blue	1 x 10
72276-01	7.5cm x 3.6m roll	● Dark blue	1 x 10
72276-02	10cm x 3.6m roll	● Dark blue	1 x 10
72277-00	5cm x 3.6m roll	● Purple	1 x 10
72277-01	7.5cm x 3.6m roll	● Purple	1 x 10
72277-02	10cm x 3.6m roll	● Purple	1 x 10
72275-00	5cm x 3.6m roll	● Red	1 x 10
72275-01	7.5cm x 3.6m roll	● Red	1 x 10
72275-02	10cm x 3.6m roll	● Red	1 x 10
73455-00	5cm x 3.6m roll	● Pink	1 x 10
73455-01	7.5cm x 3.6m roll	● Pink	1 x 10
73455-02	10cm x 3.6m roll	● Pink	1 x 10
73453-00	5cm x 3.6m roll	● Light blue	1 x 10
73453-01	7.5cm x 3.6m roll	● Light blue	1 x 10
73453-02	10cm x 3.6m roll	● Light blue	1 x 10
73454-00	5cm x 3.6m roll	● Green	1 x 10
73454-01	7.5cm x 3.6m roll	● Green	1 x 10
73454-02	10cm x 3.6m roll	● Green	1 x 10
73457-00	5cm x 3.6m roll	Mixed*	1 x 10
73457-01	7.5cm x 3.6m roll	Mixed*	1 x 10
73457-02	10cm x 3.6m roll	Mixed*	1 x 10

\* Mixed pack: Contains 2 rolls Light Blue, 2 rolls of Red, 2 rolls of Purple, 2 rolls of Pink, 2 rolls of Dark Blue

- Easy to apply
- Clear radiograph viewing
- Very conformable
- Rigid support

Delta-Cast® Elite has been designed with ease of application and patient comfort in mind. Our patented fibreglass-free casting material combines strength and rigidity with soft edges for enhanced patient comfort.

#### Patented Fibreglass-Free Substrate

Delta-Cast® Elite has a patented polyester substrate featuring extensible yarns that easily shape to body contours, providing enhanced moulding capabilities for both primary and secondary casting applications and producing less dust during cast removal.

#### Patented Resin System

Ensures maximum lamination and end laydown for strong, long-lasting casts.

#### Indications

- Rigid primary and secondary casting applications where enhanced radiograph viewing is important

# Delta-Cast® Prints

## Patterned Polyester Casting Bandage



- Easy to apply
- Smooth finish, soft edges
- Clear radiograph viewing
- Available in five popular patterns

Delta-Cast® Prints has been designed with ease of application and patient comfort in mind. Our patented fibreglass-free casting material combines strength and rigidity with soft edges for enhanced patient comfort.

Delta-Cast® Prints large range of colourful patterns assist in overcoming anxiety of patients when having their cast applied.

### Fibreglass-Free Substrate

Delta-Cast® Prints is comprised of polyester substrate which features extensible yarns that easily shape to body contours, providing enhanced molding capabilities for both primary and secondary casting applications and produces less dust during cast removal.

### Patented Resin System













The resin formula of Delta-Cast® Prints with slip agent surfactant creates a slippery touch during working time for an optimal moulding feeling. This gives you the freedom to work with the glove of your choice, giving you a reliable precise working window.



### Indications

- Rigid primary and secondary casting applications where enhanced radiograph viewing is important

### Ordering information

Ref. No.	Size	Items per Unit
72273-22	 Camouflage 5cm x 3.6m	bx/10 rolls
72273-06	 Camouflage 7.5cm x 3.6m	bx/10 rolls
72273-20	 Paw 5cm x 3.6m	bx/10 rolls
72273-21	 Paw 7.5cm x 3.6m	bx/10 rolls
72273-07	 Pastel 7.5cm x 3.6m	bx/10 rolls
72273-17	 Pastel 5cm x 3.6m	bx/10 rolls
72273-02	 Dinosaurs 5cm x 3.6m	bx/10 rolls
72273-40	 Pink Camouflage 5cm x 3.6m	bx/10 rolls
72273-41	 Pink Camouflage 7.5cm x 3.6m	bx/10 rolls
72273-69	 Blue/Grey Camouflage 5cm x 3.6m	bx/10 rolls
72273-70	 Blue/Grey Camouflage 7.5cm x 3.6m	bx/10 rolls
72273-64	 Leopard 5cm x 3.6m	bx/10 rolls
72273-66	 Leopard 7.5cm x 3.6m	bx/10 rolls

Available September 2026

# Delta-Cast® Soft

## Semi-Rigid Polyester Casting Tape



- High conformability
- Controllable set time
- Superior durability
- High patient comfort
- Earlier patient mobility
- Versatile applications

Delta-Cast® Soft is fibreglass-free and was designed to provide variable support to fractures and soft tissue injuries. Its semi-rigidity allows for more flexibility and mobility, thus helping to reduce immobilisation related problems such as atrophy or joint stiffness. As a result, the overall healing process tends to be shortened.

### Fibreglass-Free Substrate

Delta-Cast® Soft has multi-directional knit polyester substrate for excellent conformability, wrinkle free applications and enhanced moulding capabilities.



### Indications

- Casting applications where a semi-rigid cast is required. Most commonly used for Talipes, serial casting and can be removed using scissors or by unwrapping

### Ordering information

Code	Size	Colour	Pack Qty
72708-02	2.5cm x 1.8m roll	○ White	1 x 10
72708-12	5cm x 3.6m roll	○ White	1 x 10
72708-22	7.5cm x 3.6m roll	○ White	1 x 10
72708-32	10cm x 3.6m roll	○ White	1 x 10
72708-08	5cm x 3.6m roll	● Red	1 x 10
72708-18	7.5cm x 3.6m roll	● Red	1 x 10
72708-28	10cm x 3.6m roll	● Red	1 x 10
72708-05	5cm x 3.6m roll	● Blue	1 x 10
72708-15	7.5cm x 3.6m roll	● Blue	1 x 10
72708-25	10cm x 3.6m roll	● Blue	1 x 10
72708-90	5cm x 3.6m roll	Mixed*	1 x 10
72708-91	7.5cm x 3.6m roll	Mixed*	1 x 10

\* Mixed pack: Contains 2 rolls of Hearts, 2 rolls of Paw Prints, 2 rolls of Red, 2 rolls of Blue, 2 rolls of Black

Secondary Immobilisation

Available  
September  
2026

# Supra and Sub Cast Protection



# Soffban® Natural

## Natural Orthopaedic Padding



- Absorbent
- Conformable
- Easy to tear
- Soft
- Autoclavable
- Paper wrapped

Soffban® Natural has been developed to provide the conformability and easy handling normally associated with synthetic paddings, whilst providing the softness and absorbency of a natural padding. This makes it ideal for use under Gypsona® Plaster of Paris bandages.

### Advantages

**Absorbent** – The Soffban® Natural fleece absorbs sweat and exudate, reducing the risk of skin maceration and irritation, particularly in hot climates.

**Conformable** – Soffban® Natural conforms well around awkward body contours, eliminating the need for pleats or tucks during application, to produce even coverage and reduce the chance of pressure points.

**Easy to tear** – Soffban® Natural tears and teases apart easily, aiding rapid application and reducing the risk of stressing the fracture while finishing padding application.



**Soft** – The 100% Rayon fleece of Soffban® Natural is soft and comfortable for the patient, providing excellent cushioning and protection.

**Autoclavable** – Soffban® Natural is autoclavable making it suitable for use in theatre, or for any procedures where sterility is desirable.

**Paper-Wrapped** – The paper wrap on Soffban® Natural does not need to be removed for autoclaving, but maintains the integrity of the roll during this process.

### Indications

- Padding of orthopaedic conditions
  - POP casts
  - Synthetic casts
- Compression bandaging

### Ordering information

Ref. No.	Size	Items per Unit
71472-00	5cm x 2.7m	12 rolls
71473-00	7.5cm x 2.7m	12 rolls
71469-00	10cm x 2.7m	12 rolls
71470-00	15cm x 2.7m	12 rolls

# Soffban® Synthetic

## Water-Resistant Orthopaedic Padding



- Highly conformable for easy shaping to all body contours and joints
- Easily tearable for quick and trouble free application
- High loft for maximum cushioning and protection
- Feathers out easily, giving a smooth finish
- Low moisture absorbency minimises skin maceration

Soffban® is a comfortable, soft and smooth orthopaedic padding. It features a high loft for maximum cushioning and protection and feathers out easily, giving the padding a smooth finish.

Soffban® is highly conformable for easy shaping around awkward body contours and joints. The padding is resistant to moisture absorbency, minimising the risk of skin maceration. Soffban® is easily tearable for quick, trouble-free application and is also autoclavable, making it suitable for use in theatre or sterile procedures.



### Indications

- Padding of orthopaedic conditions
  - POP casts
  - Synthetic casts
- Compression bandaging

### Ordering information

Ref. No.	Size	Items per Unit
71464-01	5cm x 2.7m	12 rolls
71467-01	7.5cm x 2.7m	12 rolls
71486-05	10cm x 2.7m	12 rolls
71465-01	15cm x 2.7m	12 rolls



# Artiflex® Soft

## Orthopaedic Padding



- Provides excellent cushioning and soft for patient protection
- Padding allows moisture to pass through so it can evaporate
- Provides exceptional conformability and a smooth profile
- Padding can be sterilized for theatre use

Artiflex® Soft synthetic cast padding is composed of a blend of 85% polyester and 15% polyolefin providing excellent protection and comfort to the patient. Polyester retains good wicking properties, which allows it to transport moisture and rapidly dry out.



### Ordering information

Ref. No.	Size	Items per Unit
73048-02	5cm x 2.7m	pk/6 rolls
73048-00	7.5cm x 2.7m	pk/6 rolls
73048-01	10cm x 2.7m	pk/6 rolls
73048-03	15cm x 2.7m	pk/6 rolls

# Velband™

## Absorbent Orthopaedic Padding



Velband™ is hypoallergenic bandage with a unique three-layer structure for easy application and long-term comfort. It provides excellent cushioning and moisture management under Plaster of Paris or synthetic casts, avoiding irritation and pressure sores by keeping the skin dry and comfortable.

Velband™ is easy to handle and remove, and is autoclavable for theatre use.

### Indications

- Padding of orthopaedic conditions
  - POP casts
  - Synthetic casts
- Compression bandaging

### Ordering information

Ref. No.	Size	Items per Unit
72315-01	7.5cm x 2.75m	12 rolls
72315-02	10cm x 2.75m	12 rolls
72315-04	15cm x 2.75m	12 rolls



# AquaCast® Liner

## Waterproof Cast Liner



AquaCast® is a waterproof cast liner specially designed to reduce the incidence of problems associated with synthetic casts. AquaCast® allows water to drain quickly from the ends of the cast, enabling patients to shower and bathe as normal and avoid the hassles associated with keeping traditional casts dry.



AquaCast® is highly conformable, with the adhesive coating on one side of the liner allowing for easy application and minimal slippage on the limb.

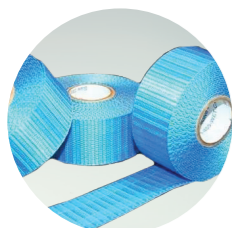

Removal of the cast is also simplified by use of the Saw Stop cut-resistant strip under the cast, which increases the safety margin during saw contact.

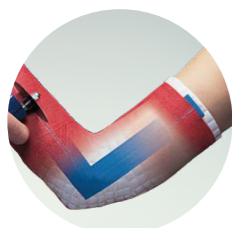

# Delta-Dry®

## Water Resistant Cast Padding



- Conformable
- Water resistant
- Traditional cast removal with no extra components needed

The unique patented technology in Delta-Dry® has created a water resistant cast padding which allows easy application by the clinician and affords the patient all the lifestyle benefits of a cast they can get wet.

### Advantages

- Allows patients to shower, swim and bathe like normal
- No special tools are needed for application or removal
- Conformable enabling patient to having increased comfort and protection
- Easy to apply
- Better long term water resistance
- Offers more under cast protection
- Eliminates the need for stockinette



### Indications

- Non-displaced and minimally displaced fractures
- Sprains
- Post operative (healed incisions)

### Ordering information

Ref. No.	Size	Items per Unit
<b>Bandage</b>		
73443-00	5cm x 2.4m	bx/12
73443-01	7.5cm x 2.4m	bx/12
73443-02	10cm x 2.4m	bx/12

Ref. No.	Size	Items per Unit
<b>Softliner</b>		
72779-01	2.5cm x 10m	bx/1
72779-02	5cm x 10m	bx/1
72779-03	7.5cm x 10m	bx/1
72779-04	10cm x 10m	bx/1
72779-05	12.5cm x 10m	bx/1

Ref. No.	Size	Items per Unit
<b>Stockinette</b>		
74564-00	2.5cm x 10m	bx/1
74564-01	5cm x 10m	bx/1
74564-02	7.5cm x 10m	bx/1
74564-03	10cm x 10m	bx/1
74564-04	12.5cm x 10m	bx/1

### Indications

- Injury:
  - Non-displaced and minimally displaced fractures
  - Sprains
  - Post operative (healed incisions)
- Treatment:
  - Short-arm and below-knee casts
  - Hydrotherapy
  - Sports people and others with an active lifestyle
  - Patients facing particular care and hygiene issues, especially incontinence

### Ordering information

Ref. No.	Size	Items per Unit
<b>Waterproof Cast Liner</b>		
73365-10	5cm x 1.7m	bx/12
73365-11	7.5cm x 1.7m	bx/12
73365-12	10cm x 1.7m	bx/12
<b>Hipster Protective Liner</b>		
73365-50	Size 2	pk/1
73365-51	Size 4	pk/1
73365-52	Size 6	pk/1
73365-53	Size 8	pk/1
<b>Saw Stop Strip</b>		
73363-08	3.1cm x 3m	1 roll

Undercast Materials

# Protouch® Stockinette

## Synthetic and Cotton Stockinette

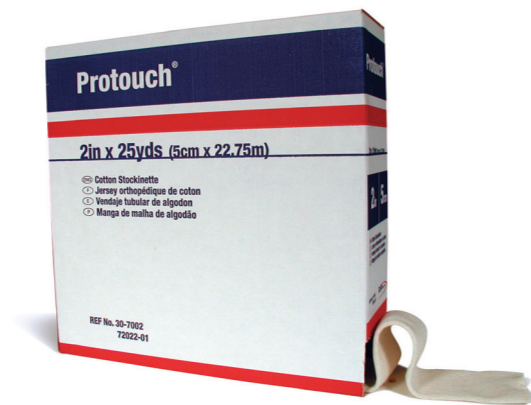

- Available in synthetic or cotton
- Conformable and easy to use
- Available in a wide range of sizes

Protouch® synthetic and cotton stockinettes provide patients with optimum comfort at the critical juncture where the skin meets the cast.

### Protouch® Synthetic Stockinette

- Made of synthetic fibres to retract moisture away from the skin for rapid evaporation
- Soft and conformable providing good cushioning and comfort to the patient
- Stretches to three times its normal width to conform to an arm, leg or body
- Available in a variety of sizes for all casting applications

### Protouch® Cotton Stockinette

- Ideal material for an initial undercast layer
- Made of a high-grade knitted cotton
- Soft and conformable providing good cushioning and comfort to the patient
- Stretches to three times its normal width to conform to an arm, leg or body
- Available in a variety of sizes for all casting applications

### Ordering information

Ref. No.	Size	Items per Unit
<b>Synthetic Stockinette</b>		
72026-00	2.5cm x 22.75m	bx/1
72026-01	5cm x 22.75m	bx/1
72026-02	7.5cm x 22.75m	bx/1
72026-03	10cm x 22.75m	bx/1
72026-05	20cm x 22.75m	bx/1
<b>Cotton Stockinette</b>		
72022-00	2.5cm x 22.75m	bx/1
72022-01	5cm x 22.75m	bx/1
72022-02	7.5cm x 22.75m	bx/1
72022-03	10cm x 22.75m	bx/1
72022-04	15cm x 22.75m	bx/1
72022-05	20cm x 22.75m	bx/1

# Delta Terry-Net™ S

## Terry Cloth Stockinette



- Conformable and easy to apply
- Cost-effective roll presentation
- Soft for patient comfort and protection
- Lightweight, flexible and durable

Delta Terry-Net™ S is for use where extra patient comfort is required. Supplied in an easy-to-use dispensing box for improved storage and handling, Delta Terry-Net™ S is latex free.

### Terry Knit Design

The terry knit design of Delta Terry-Net™ S allows clinicians greater flexibility to accommodate varying limb sizes as well as increased treatment flexibility in the management of specialised casting indications, such as total contact casting. The terry knit design also allows for enhanced protection to fragile skin when managing skin tears.

### Terry Knit Fibres

The soft moisture wicking fibres of Delta Terry-Net™ S provide improved patient comfort and reduced maceration whilst providing increased protection both in-situ and upon removal.

### Ordering information

Ref. No.	Size	Items per Unit
72306-00	5cm x 13.5m	bx/1
72306-01	7.5cm x 13.5m	bx/1
72306-02	10cm x 13.5m	bx/1

# Cast Removal, Accessories, Tapes & Bandages



# Delta-Cast® Serene™

## Cast Remover

### Meet the new cast removing device

- The static blade does not generate airborne particles, keeping the cast room air cleaner without the need for a vacuum system
- The weight of the balanced device rests on the cast – enabling almost effortless one-handed operation
- Due to its quiet operation, it allows for easier communication and reduced anxiety for patients
- Effortlessly cuts through up to 10 layers of synthetic cast material
- The blade lasts for up to 200 cuts, is quick to change and easy to clean
- Easy to move from room to room with no cumbersome vacuum system
- The concealed blade that does not produce vibrations or heat – making it less intimidating for patients, especially children
- The hidden static blade and protective foot and hidden blade, helping to mitigate the risk of cuts and burns



Code	Product	Pack Qty
76289-03	Delta-Cast® Serene™ (inc. all components)	1 x 1
76289-07	Delta-Cast® Serene™ Blades	1 x 10
76289-06	Delta-Cast® Serene™ Replacement footer plate*	1 x 1
76289-05	Delta-Cast® Serene™ Replacement Pin*	1 x 1
76289-12	Delta-Cast® Serene™ Replacement Power cable*	1 x 1

\*Please note, replacement pin, footer plate and power supply are available if required, these are not a mandatory purchase

# deSoutter

## Cast Removal System – CC4



The powerful CC4 CleanCast™ saw and dust extraction system comprises of the CC4 mains voltage oscillating saw, extraction hood and the CCS portable extractor unit with highly efficient dust filtration capability.

### Powerful 110 Watt Motor

Maintains rapid and efficient cutting on the thickest of body casts

### Control and Maneuverability

Knurled grip close to saw blade provides operator with greater flexibility of movement.

### Visibility

Clear polycarbonate extraction hood offers excellent visibility when cutting. The hood is fully rotatable to suit the most convenient cutting position.

### Low Noise

The CCS Extractor Unit is exceptionally quiet at only 58dB(A) and has two speed settings.

### Four Levels of Filtration

A filtration level of 99.997% on all dust particles greater than 0.5 microns is achieved with the extractor.

### CC4 Saw Specifications

Oscillating speed:	14000 osc/min.
Voltage:	230V
Weight:	1.3 kg
Sound level:	70 dB(A)
Length:	333 mm

### Ordering information

Ref. No.	deSoutter Code	Description	Items per Unit
CC4 Saw			
72030-06	1281444	Cast Saw deSoutter Model CC4	1
72033-08	6250	Cast Saw Blade to suit deSoutter 64mm	1

# deSoutter

## Cast Removal System – CC7

### Smaller, Lighter and more Powerful

Our engineers have used state of the art brushless motor technology to reduce weight, and deliver class leading power of 138 Watts an increase of 38%.

### Low vibration

Improvements to the motor housing by adding vibration absorbing material and acoustic baffles have reduced vibration levels by 25% and noise by 3dB.

### Ergonomically positioned operating switch

Conveniently located On/Off switch improves efficiency and ease of use.

### Keyless blade loading

Keyless blade loading has been designed to improve usability whilst at the same time lowering vibration levels by combining De Soutter Medical's 'tapered lock' design - which in turn eliminates lost motion between moving parts.

### Manoeuvrability and stability

The introduction of a stable 5 wheel extraction stand provides effortless handling.

### Improved HEPA filter technology complete with a fully sealed dust bag, eliminates dust emission

Improvements in HEPA filter technology has meant a higher degree of filtration with less inventory. Dust bags now come with a sealing cover to prevent dust from escaping during bag changes.



### Ordering information

Ref. No.	deSoutter Code	Description	Items per Unit
<b>CC7 Saw</b>			
72035-26	1292554	De Soutter CC7 Cast Saw (Saw Only)	1
72035-46	1293114	De Soutter CC7 Extractor (Extractor Only)	1
73062-06	19600	De Soutter CC7 Extractor Hose Kit (2M)	1
73062-13	670123	De Soutter CC7 Extractor Dust Bag	10
73062-12	670113	De Soutter CC7 Extractor Filter	1
72033-20	19610	De Soutter CC7 Blade 64mm PTFE	5
72033-22	19660	De Soutter CC7 Blade 64mm ZRN	5

Order all 3 items for complete system

# deSoutter

## Battery Powered Saw – CSB-100



The deSoutter Medical CSB-100 saw permits the user total freedom of movement which is particularly useful for emergency departments, ward work, veterinary clinics and numerous other applications where the cordless concept is the only practical solution.

### CSB-100 Saw Specifications

Oscillating speed: 16000 osc/min.  
Voltage: 10.8 Vdc  
Weight: 1.05 kg

### Battery Charger Specifications

Supply voltage: 100-240 Vac  
Supplier frequency: 50-60 Hz

Supplied with interchangeable mains supply adaptors for use in most countries.

### Ordering information

Ref. No.	deSoutter Code
<b>CSB-100 Cast Saw</b>	
1286774	73065-00
Includes:	CSB-100 Saw
	CB-100 Battery x 2
	BC-100 charger
	Saw Blade
	Hexagon Wrench
	Carry Case

# deSoutter

## Battery/Mains Powered Saw – CSP-201

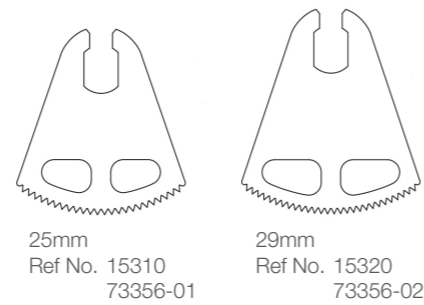

Specifically developed for paediatric use, the Red Dot award winning CSP System is exceptionally quiet and compact minimising patient anxiety. The CSP System offers both battery and mains power options, and lithium ion battery technology provides an unrivalled power to weight ratio.

### CSP-1201 Saw Specifications

Oscillating speed: 14800-17500 osc/min.  
 Weight: 319 grams  
 Sound level: 55 dB(A)

### Battery Specifications

Capacity: 30.8 Wh  
 Weight: 437 grams  
 Charging time from flat: < 3 hours

Supplied with interchangeable mains supply adaptors for use in most countries.

- Soft start feature with noise control helps minimise patient anxiety
- Continuous 2 hour – cutting performance
- Built-in service reminder – 300 charging cycles
- Display allows the user to select the optimum cutting speed and view the remaining battery capacity
- Micro processor controlled voltage booster ensures constant cutting performance - zero deterioration

### Ordering information

Ref. No.	deSoutter Code
<b>CSP-201 Pro Cast Saw</b>	
1286994	73356-00
Includes:	
	CSP-201 Saw and Cable
15250	BP-201 Battery Pack Pro
15270	IC-201 Inter Connector
15280	PS-201 Power Supply
15290	Carry Case
15300	Wrench
73356-01	15310 Saw Blade
73356-02	15320 Saw Blade

# Cast Room Accessories

### Cast Saw Blades

- Available in PTFE (Teflon), extra durable titanium nitride and stainless steel coatings
- Range of sizes and profiles to cover all requirements
- Suits deSoutter Cast Saws

### Cast Spreaders

- High quality surgical stainless steel construction
- Spring loaded handles for easy use

### Cast Removal Shears

- Ideal for cutting casting materials, paddings, felt, etc
- High quality surgical stainless steel construction

### Cast Scissors

- Lister 200mm bandage scissors
- High quality surgical stainless steel construction

### Bolsters

- Leg bolster
- Elbow bolster

### Ordering information

Ref. No.			Items per Unit	
<b>Cast Saw Blades</b>				
6230	Circular PTFE Coated	44mm	1	
72033-25	6240	Circular PTFE Coated	50mm	1
72033-08	6250	Circular PTFE Coated	64mm	1
72033-03	6260	Segment PTFE Coated	80mm	1
72033-10	67400065	Circular Stainless Steel	64mm	1
<b>Cast Spreaders</b>				
72046-11	5120	Small	1	
73066-00	5130	Large	1	
<b>Cast Removal Shears</b>				
73066-01	7680		1	
<b>Cast Scissors</b>				
72937-00		20cm Lister	1	
72294-02		20cm Clean Cut	1	
<b>Bolsters</b>				
73049-01		Leg bolster	1	
73049-03		Elbow bolster	1	



Cast Removal Equipment

## Leukoplast® Standard

Rigid, tan, zinc oxide tape

### Product Benefits

- Tan rigid tape
- Strong adhesion for long-lasting wear
- Porous, allowing skin to breathe
- Water-repellent
- Well tolerated by normal skin

Code	Size	Pack Qty
01691-01	1.25cm x 9.2m	24/drum
01692-01	2.5cm x 9.2m	12/drum
01690-00	3.8cm x 9.2m	8/drum
01693-01	5cm x 9.2m	6/drum
01521-00*	1.25cm x 5m	24/box
01522-00*	2.5cm x 5m	12/box
01524-00*	5cm x 5m	6/box
47725-00*	7.5cm x 5m	4/box

\*Antimicrobial spoils



## Leukoplast® elastic

Elastic, tan, zinc oxide tape

### Product Benefits

- Tan coloured
- Elastic for flexible area dressing retention
- Elastic, enabling easier application
- Flexible to conform to body movement
- Strong zinc oxide adhesive for long lasting wear
- Well tolerated by normal skin

Code	Size	Pack Qty
01061-00*	2.5cm x 1m	12/box
01062-00*	5cm x 1m	12/box
01071-00*	2.5cm x 2.5m	12/box
01072-00*	5cm x 2.5m	12/box
01073-00*	7.5cm x 2.5m	6/box



## Easifix® Cohesive

Self adhesive retention bandage

### Product Benefits

- Economical 10m rolls can be cut so you only use what you need
- Cohesive construction sticks to itself - not to skin or clothing
- Non slip, highly conformable construction allows bandaging of difficult areas

Code	Size	Pack Qty
71439-21	4cm x 2m	10/box
71439-19	6cm x 2m	10/box
71439-16	8cm x 2m	10/box
71439-17	10cm x 2m	10/box
71439-20	6cm x 10m	10/box
71439-18	8cm x 10m	10/box



## Handy® Gauze Cohesive

Self adhesive retention bandage

### Product Benefits

- White, low bulk bandage
- Sticks to itself, not skin or clothing
- Air-permeable
- Economical: can be cut to any length

Code	Size	Pack Qty
92557-00	2.5cm x 2m	2/box
92557-01	6cm x 2m	1/box
92557-02	8cm x 2m	1/box
92557-03	10cm x 2m	1/box
92557-04	6cm x 10m	1/box
92557-05	8cm x 10m	1/box
92557-06	10cm x 10m	1/box



## Elastolite®

### Light support crepe bandage

#### Product Benefits

- High twist cotton yarns ensure excellent stretch and regain characteristics thus permitting free movement while maintaining effective therapy
- Selvedged edges prevent fraying
- Non bleached natural colour
- Washable

Code	Size	Pack Qty
NON-STERILE		
72092-25	5cm x 1.5m	12/box
72092-28	7.5cm x 1.5m	12/box
72092-26	10cm x 1.5m	12/box
72092-27	15cm x 1.5m	12/box
STERILE		
72092-58	5cm x 1.5m	160/box
72092-56	7.5cm x 1.5m	136/box
72092-59	10cm x 1.5m	90/box
72092-57	15cm x 1.5m	18/box



**Actimove®**  
Feel good. Move better.

## Tensogrip®

### Tubular support bandage

#### Product Benefits

- Easily applied, circular knitted construction
- Design ensures consistent even pressure is applied
- Available in tan or white
- Economical – cut off only what you need
- Washable, re-usable and durable

Code	Size	Colour	Pack Qty
71513-00	Size A 4.5cm x 10m	White	1/box
71514-00	Size B 6.25cm x 10m	White	1/box
71519-00	Size C 6.75cm x 10m	White	1/box
71515-00	Size D 7.5cm x 10m	White	1/box
71520-00	Size E 8.75cm x 10m	White	1/box
71516-00	Size F 10cm X 10m	White	1/box
71521-00	Size G 12cm x 10m	White	1/box
71517-00	Size J 17.5cm x 10m	White	1/box
71523-00	Size K 21.5cm x 10m	White	1/box
71522-00	Size L 32.5cm x 10m	White	1/box
71514-01	Size B 6.25cm x 10m	Tan	1/box
71519-01	Size C 6.75cm x 10m	Tan	1/box
71515-01	Size D 7.5cm x 10m	Tan	1/box
71520-01	Size E 8.75cm x 10m	Tan	1/box
71516-01	Size F 10cm X 10m	Tan	1/box
71521-01	Size G 12cm x 10m	Tan	1/box



# INDEX

## ADULT ASSORTMENT

### Actimove® SPORTS EDITION

#### Wrist & Thumb

Actimove® Wrist Support, Adjustable	50
Actimove® Wrist Stabilizer, Removable Metal Stay, Left or Right	52
Actimove® Thumb Stabilizer, Extra Stays	54

#### Elbow

Actimove® Elbow Strap, Hot/Cold Pack	55
Actimove® Elbow Support, Adjustable	56

#### Knee

Actimove® Patella Strap, Adjustable	57
Actimove® Knee Support, Open Patella Adjustable	58
Actimove® Knee Stabilizer, Adjustable Horseshoe and Stays	59

#### Ankle

Actimove® Ankle Support	60
Actimove® Ankle Stabilizer, Criss-Cross Straps	62

#### Back & Lumbal

Actimove® Back Support, 4 Stays, Adjustable Double Layer Compression	64
--	----

### Actimove® EVERYDAY SUPPORTS

#### Wrist & Thumb

Actimove® Wrist Stabilizer Carpal, Pre-shaped Metal Stay	68
--	----

#### Knee

Actimove® Knee Support, Closed Patella, 2 Stays	69
---	----

#### Ankle

Actimove® Ankle Support	70
-------------------------	----

### Actimove® ARTHRITIS CARE

#### Wrist

Actimove® Wrist Support	74
-------------------------	----

#### Hands

Actimove® Arthritis Gloves	76
----------------------------	----

#### Knee

Actimove® Knee Support	78
------------------------	----

### Actimove® PROFESSIONAL LINE

#### Wrist & Thumb

Actimove® Rhizo Forte, Thumb Orthosis	84
Actimove® Manus Air	86
Actimove® ManuMotion, Wrist Support	88
Actimove® Manus Forte, Wrist Brace	90
Actimove® Manus Forte Plus, Wrist & Thumb Brace	92

#### Elbow

Actimove® EpiMotion, Elbow Support	96
------------------------------------	----

#### Shoulder

Actimove® Sling Comfort, Arm Sling – Dispenser Box	100
Actimove® Mitella, Arm Sling	102
Actimove® Mitella Comfort, Comfort Arm Sling	104
Actimove® Umerus, Shoulder Immobilizer	106
Actimove® Umerus Comfort, Comfort Shoulder Immobilizer	108
Actimove® Shoulder Abduction Sling, Shoulder Immobilizer	110

#### Knee

Actimove® GenuMotion, Knee Support	114
Actimove® Post-OP ROM Knee Brace	116
Actimove® Genu Tri-Panel, Knee Immobilizer	117
Actimove® Genu Eco, Knee Immobilizer	118

#### Ankle

Actimove® TaloMotion, Ankle Support	122
Actimove® Standard Walker, Ankle Walker	124
Actimove® Standard Air Walker, Ankle Walker	125

#### Foot

Actimove® Offloading Shoe, Cast Boot	128
Actimove® Cast Shoe Rocker Sole, Rocker Sole Shoe	129
Actimove® Post-Op Shoe Open Toe	130

#### Cervical

Actimove® Cervical, Cervical Collar Medium Density	134
Actimove® Vertebrace, Cervical Collar	136

## INDEX

### KIDS ASSORTMENT

#### Actimove® KIDS

##### Wrist

Actimove® Wrist Stabilizer, Removable Metal Stay, Left or Right 142

##### Shoulders

Actimove® Mitella, Arm Sling 143

Actimove® Sling, Arm Sling – On a Roll 144

#### Actimove® PROFESSIONALE LINE

##### Cervical

Actimove® Vertebrace, Cervical Collar 148

##### Foot

Actimove® Cast Shoe Rocker Sole, Rocker Sole Shoe 149





## Actimove® – for your and your patients' needs

Actimove offers a broad portfolio of medically engineered braces and supports for most needs and patient groups, coming in five distinctive ranges. Actimove Professional Line, Actimove Sports Edition, Actimove Everyday Supports, Actimove Arthritis Care and Actimove Kids give patients the confidence to manage their pain and to take on their daily life challenges.

Actimove's packing design brings a fresh look with high impact into stores. The design also supports easy product choice – for both professionals and those self-selecting.

Drawing on over 80 years of experience in non-invasive orthopedics<sup>1</sup>, Actimove prides itself on providing medical devices that are reliable and thoroughly tested. Actimove braces and supports help to manage pain with excellent functional performance based on biomechanics. They are tested for biocompatibility, are highly comfortable and made from carefully chosen materials. Driven by constant innovation, Actimove keeps working on improving its offers for you.

Actimove is a brand of Essity, a leading hygiene and health company dedicated to improving people's well-being. Actimove stands for trusted products and services to support sustainable business growth.

Whether users are running a marathon, recovering from an injury, overcoming daily arthritis, or recurring pain when moving, they can rely on Actimove to help them with optimized support and pain-relief.

**Actimove. Feel good. Move better.**

<sup>1</sup> In the market since 1940: the leading Plaster of Paris brand Gypsona®

## ADULT ASSORTEMENT

# Choose the right product for your patients.

### Actimove® SPORTS EDITION

Keep cool and dry for great comfort



- Aids pain relief after acute sports injuries
- For the active younger people
- To help prevent re-injuries
- Made with COOLMAX® AIR Technology
- Neoprene-free, suitable for those sensitive to latex, as this product is not made with natural rubber latex.

### Actimove® ARTHRITIS CARE

Soothing warmth for pain relief



- Aids pain relief for chronic osteoarthritis and rheumatoid arthritis
- Designed for the elderly to help increase mobility
- Ceramic yarns retain and reflect body heat
- Medical compression for support and stability
- Suitable for those sensitive to latex, as this product is not made with natural rubber latex.

### Actimove® EVERYDAY SUPPORTS

Stability for daily mobility



- Aids pain relief in chronic degenerative joint diseases
- Designed for the elderly looking for stability
- Medical compression to help reduce edema
- Motion-Comfort-Zone for sensitive areas
- Suitable for those sensitive to latex, as this product is not made with natural rubber latex.

### Actimove® PROFESSIONAL LINE

Excellent functionality for pain relief



- Physician recommended or prescribed
- For professional treatment of acute injuries, post-op use and rehabilitation of chronic orthopedic issues
- Pain relief from functional design based on biomechanics
- Control and guide joint movement
- Support - Stabilize - Immobilize

# Actimove® SPORTS EDITION

Younger, sporty people often wear neoprene braces & supports after sports injuries or to prevent re-injury. A major complaint about these is that they are too hot to wear and cause excessive sweating.<sup>1</sup>

Actimove® Sports Edition aids pain relief and healing through balanced warmth and medical compression. They offer great comfort from excellent moisture management and skin-friendly materials.

- Made with **COOLMAX® AIR<sup>2</sup>** technology, Actimove® Sports Edition is engineered for quick drying and exceptional breathability to keep people cool and dry.
- The perforated **performance material** of Actimove® Sports Edition is neoprene-free, friendly to the skin, and suitable for those sensitive to latex, as this product is not made with natural rubber latex.
- Furthermore, **medical compression** properties for support and stability help reduce swelling and manage pain relief.

**COOLMAX®**  
PRO

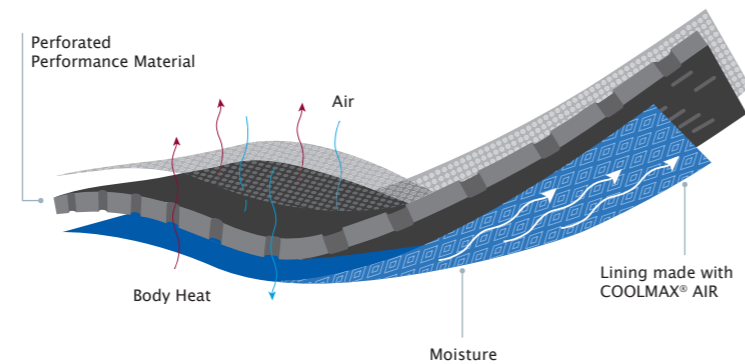

3D Diamond Lining with COOLMAX® AIR



Perforated Performance Material



<sup>1</sup> Essity End-User Validation Research 10/2012; n= 400 OSO shoppers in USA

<sup>2</sup> COOLMAX® AIR is a trademark of The LYCRA company

# Actimove® Wrist Support

## Adjustable

### Durable, adjustable support for weak or injured wrists

- Pain relief and healing are supported through balanced warmth and medical compression.
- Great comfort with exceptional breathability through quick drying perforated performance material.
- Neoprene-free, made with COOLMAX® AIR technology.
- For comfort, adjust the level of support, no matter the activity.
- Allows for comfortable, dry hands based on the open palm design.
- For a comfortable fit, oval-cut thumb opening.
- Suitable for those sensitive to latex, as this product is not made with natural rubber latex.
- Universal sizing.
- Can be worn left or right.
- For stock keeping, long shelf life of five years.
- For better hygiene, product or part of the product is machine washable. Always read the washing instructions on the packaging.

This product is intended to provide support/stabilization to the wrist.

**Fields of application include:**

- Weak or injured wrist
- Overuse syndromes
- Mild sprains and strains
- Arthritis
- Support during everyday activities



3D Diamond Lining with COOLMAX® AIR



	Ref.	Size	Measurements	Color
	75626-10	Universal	5 <sup>1</sup> / <sub>2</sub> " - 8" / 14 - 20 cm	Black

# Actimove® Wrist Stabilizer

Removable Metal Stay, Left or Right Hand

**Anatomically shaped stay for secure stabilization, managing sprains and strains**

- Pain relief and healing are supported through balanced warmth and medical compression.
- For comfort, lining made of special premium soft material.
- Comfort and good breathability through neoprene-free performance material.
- Stabilizes wrist through an anatomically shaped removable stay for left and right hand application.
- Quick and easy to fit with slip-on design and individually adjustable straps.
- Can be easily worn under clothing due to low profile.
- Suitable for those sensitive to latex, as this product is not made with natural rubber latex.
- Available in three sizes.
- Can be worn left or right.
- For stock keeping, long shelf life of five years.
- For better hygiene, product or part of the product is hand washable. Always read the washing instructions on the packaging.

This product is intended to provide support/stabilization to the wrist.

Fields of application include:

- Tendonitis
- Sprains, strains, soft tissue injuries
- Osteoarthritis
- Rheumatoid arthritis
- Post-operative care
- After cast removal



	Ref.	Size	Measurements	Color
	75729-31	S	5" - 6 <sup>1</sup> / <sub>4</sub> " / 13 - 16 cm	Black
	75729-32	M	6 <sup>1</sup> / <sub>4</sub> " - 7 <sup>1</sup> / <sub>2</sub> " / 16 - 19 cm	Black
	75729-33	L	7 <sup>1</sup> / <sub>2</sub> " - 9" / 19 - 23 cm	Black

# Actimove® Thumb Stabilizer

## Extra Stays

Anatomically shaped stays, managing thumb injuries, keeping finger dexterity

- Pain relief and healing are supported through balanced warmth and medical compression.
- For comfort, lining made of special premium soft material.
- Comfort and good breathability through neoprene-free performance material.
- Stabilization of the thumb through two integrated anatomically shaped stays.
- Firm and adjustable wrist support from powerful elastic strap.
- Full finger movement and hand dexterity from special open design.
- Suitable for those sensitive to latex, as this product is not made with natural rubber latex.
- Available in two sizes.
- Comes in black or beige.
- For stock keeping, long shelf life of five years.
- For better hygiene, product or part of the product is hand washable. Always read the washing instructions on the packaging.

This product is intended to provide support/stabilization to the thumb and wrist.

Fields of application include:

- Mild to moderate strains and sprains (e.g., skier's thumb)
- Lining made of special premium soft material
- Inflammation
- Onset of osteoarthritis
- Thumb pain from repetitive motion activities, like texting or gaming

Full Finger Movement



Ref.	Color	Ref.	Color	Size	Measurements
75636-30	Black	75636-32	Beige	S/M	5 1/2" - 7 1/2" / 14 - 19 cm
75636-31	Black	75636-33	Beige	L/XL	7 1/2" - 9" / 19 - 23 cm



# Actimove® Elbow Strap

## Hot/Cold Pack

Extra pain relief and secure fit for tennis and golfer elbows

- Enjoy sports, as pain relief and healing are supported through balanced warmth and medical compression.
- Made with COOLMAX® AIR technology
- Comfort and good breathability through neoprene-free performance material.
- Extra pain relief supported by a removable therapeutic hot/cold pack.
- For a secure fit, made with silicone dot lining.
- Suitable for those sensitive to latex, as this product is not made with natural rubber latex.
- Universal sizing.
- Can be worn left or right.
- For stock keeping, long shelf life of five years.
- For better hygiene, product or part of the product is machine washable. Always read the washing instructions on the packaging.

This product is intended to support the elbow.

Fields of application include:

- Tennis, golfer elbow (epicondylitis)



Hot/Cold Pack



Silicone Dot Lining

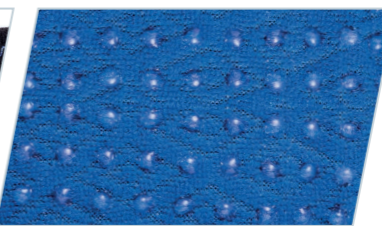

Ref.	Size	Measurements	Color
75742-30	Universal	11" - 15 3/4" / 28 - 40 cm	Black



# Actimove® Elbow Support

Adjustable

**Slip-on design with easy application and adjustment**

- Enjoy sports, as pain relief and healing are supported through balanced warmth and medical compression.
- For comfort, lining made of special premium soft material.
- Comfort and good breathability through neoprene-free performance material.
- Quick and easy to fit with slip-on design and individually adjustable straps.
- Suitable for those sensitive to latex, as this product is not made with natural rubber latex.
- Universal and Universal Plus sizing.
- Can be worn left or right.
- For stock keeping, long shelf life of five years.
- For better hygiene, product or part of the product is hand washable. Always read the washing instructions on the packaging.

**This product is intended to support the elbow.**

**Fields of application include:**

- Painful elbow injuries & prevention



Slip-On Design



Ref.	Size	Measurements	Color
75617-30	Universal	7 <sup>1</sup> / <sub>2</sub> " - 12 <sup>1</sup> / <sub>4</sub> " / 19 - 31 cm	Black



# Actimove® Patella Strap

Adjustable

**Targeted patella pain relief that stays in place**

- Enjoy sports, as pain relief and healing are supported through balanced warmth and medical compression.
- Great comfort with exceptional breathability through quick drying perforated performance material.
- Neoprene-free, made with COOLMAX® AIR technology.
- Targeted pain relief by increased pressure on patella tendon from the high density EVA shaped insert.
- Stays in place under activity due to silicone dot lining.
- For comfort, adjust the level of support, no matter the activity.
- Suitable for those sensitive to latex, as this product is not made with natural rubber latex.
- Universal sizing.
- Can be worn left or right.
- For stock keeping, long shelf life of five years.
- For better hygiene, product or part of the product is machine washable. Always read the washing instructions on the packaging.

**This product is intended to provide support/stabilization to the patella including lateral tracking.**

**Fields of application include:**

- Patella tendonitis
- Patellofemoral pain syndrome
- Chondromalacia patella
- Osgood-Schlatter disease



Silicone Dot Lining

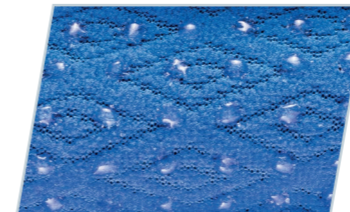

Ref.	Size	Measurements	Color
75589-20	Universal	11 <sup>1</sup> / <sub>2</sub> " - 16 <sup>1</sup> / <sub>3</sub> " / 29.5 - 41 cm	Black



# Actimove® Knee Support

## Open Patella Adjustable

Adjustable and secure protection, relieving patella pain in minor knee injuries

- Enjoy sports, as pain relief and healing are supported through balanced warmth and medical compression.
- Great comfort with exceptional breathability through quick drying perforated performance material.
- Neoprene-free, made with COOLMAX® AIR technology.
- Supports ease of application with wrap-around style for sore knees.
- For comfort, adjust the level of support, no matter the activity.
- Helps to relieve patella pain, as knee cap pressure is reduced thanks to the padded oval-shaped patella opening.
- Suitable for those sensitive to latex, as this product is not made with natural rubber latex.
- Universal and Universal Plus sizing.
- Can be worn left or right.
- For stock keeping, long shelf life of five years.
- For better hygiene, product or part of the product is machine washable. Always read the washing instructions on the packaging.

This product is intended to provide support to the knee.

Fields of application include:

- Painful knee injuries and prevention.
- Slight strains, sprains and contusions
- Minor meniscal damages
- Joint swelling

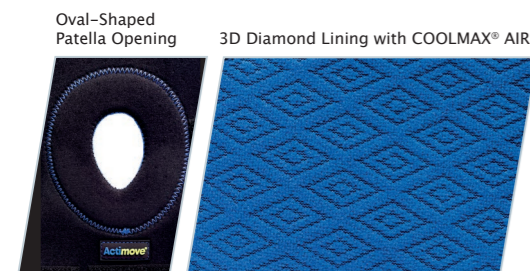

Ref.	Size	Measurements	Color
75593-10	Universal	12 1/2" - 17 1/4" / 32 - 44 cm	Black



# Actimove® Knee Stabilizer

## Adjustable Horseshoe and Stays

Sleeve design with adjustable horseshoe for improved patellar tracking

- Enjoy sports, as pain relief and healing are supported through balanced warmth and medical compression.
- Great comfort with exceptional breathability through quick drying perforated performance material.
- Neoprene-free, made with COOLMAX® AIR technology.
- Manage patellar pain syndrome with an adjustable horseshoe.
- Helps to relieve patella pain, as knee cap pressure is reduced thanks to the padded oval-shaped patella opening.
- Added knee support from medial and lateral spiral stays.
- Stays in place with improved fit through elastic hook and loop support strap.
- Easy application with convenient finger-loops.
- Improved patellar tracking through increased pressure by adjusting the horseshoe either inferiorly, superiorly, medially or laterally.
- For comfort at the back of the thigh, anterior inelastic strap instead of circumferential strap.
- Suitable for those sensitive to latex, as this product is not made with natural rubber latex.
- Available in eight sizes.
- Can be worn left or right.
- For stock keeping, long shelf life of five years.
- For better hygiene, product or part of the product is machine washable. Always read the washing instructions on the packaging.

This product is intended to provide support/stabilization to the patella including lateral tracking.

Fields of application include:

- Patellar pain syndrome
- Patellar tracking and subluxation
- Patellar instability
- Chondromalacia patella
- Patellar tendonitis



Ref.	Size	Measurements	Color
72453-00	XS	12" - 14"	Black
72453-01	S	14" - 16"	Black
72453-02	M	16" - 18"	Black
72453-03	L	18" - 20"	Black
72453-04	XL	20" - 22"	Black
72453-05	XXL	22" - 24"	Black
72453-06	3XL	24" - 26"	Black

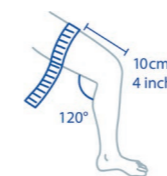

# Actimove® Ankle Support

## Elastic Wrap Around

### Ultra slim fit, extra thin, yet durable, adjustable for stability

- Enjoy sports, as pain relief and healing are supported through medical compression.
- Increased comfort and good breathability with ventilated elastic strap design.
- Ultra slim fit due to extra thin but durable material.
- For comfort, adjust the level of support, no matter the activity.
- Available in four sizes.
- Can be worn left or right.
- Available in black.
- For stock keeping, long shelf life of five years.
- For better hygiene, product or part of the product is machine washable. Always read the washing instructions on the packaging.

This product is intended to provide support/stabilization to the ankle.

**Fields of application include:**

- Painful ankle injuries & prevention
- Mild sprains
- Weak ankles
- Swelling and tenderness



Caution: This product contains natural rubber latex, which may cause allergic reaction.



	Ref.	Size	Measurements	Color
	73414-80	S	7" - 8 <sup>1</sup> / <sub>4</sub> " / 18 - 21 cm	Black
	73414-81	M	8 <sup>1</sup> / <sub>4</sub> " - 9 <sup>1</sup> / <sub>2</sub> " / 21 - 24 cm	Black
	73414-82	L	9 <sup>1</sup> / <sub>2</sub> " - 10 <sup>3</sup> / <sub>4</sub> " / 24 - 27 cm	Black



# Actimove® Ankle Stabilizer

## Criss-Cross Straps

### Simulating sports taping, increased stability for ankle and arch of foot

- Enjoy sports, as pain relief and healing are supported through balanced warmth and medical compression.
- Great comfort with exceptional breathability through quick drying performance material.
- Neoprene-free, made with COOLMAX® AIR technology.
- Increased stability around the ankle and arch of foot with criss-cross straps simulating sports taping.
- Stays in place during athletic activity with extra support from circular strap.
- Suitable for those sensitive to latex, as this product is not made with natural rubber latex.
- Universal and Universal Plus sizing.
- Can be worn left or right.
- For stock keeping, long shelf life of five years.
- For better hygiene, product or part of the product is machine washable. Always read the washing instructions on the packaging.

This product is intended to provide support/stabilization to the ankle.

**Fields of application include:**

- Mild and moderate ankle sprains
- Sports injuries
- Helps to avoid re-injuries and chronic ankle instabilities



Criss-Cross Straps



Ref.	Size	Measurements	Color
75611-30	Universal	8" - 10 <sup>1/2</sup> " / 20 - 27 cm	Black

# Actimove® Back Support

4 Stays

Adjustable Double Layer Compression

Advanced support and pain relief with comfort

- Pain relief and healing are supported through balanced warmth and medical compression.
- Great comfort with exceptional breathability through quick drying perforated performance material.
- Neoprene-free, made with COOLMAX® AIR technology.
- Advanced support and pain relief from adjustable, circumferential double-layer compression.
- Comfortable to wear, even when sitting, as flexible stays maintain positioning.
- Suitable for those sensitive to latex, as this product is not made with natural rubber latex.
- Available in six sizes.
- For stock keeping, long shelf life of five years.
- For better hygiene, product or part of the product is machine washable. Always read the washing instructions on the packaging.

This product is intended to provide support and stabilization to the lumbar joints of the back.

Fields of application include:

- Acute and chronic lower back pain
- Lumbar strains
- Muscular insufficiency
- Provides support during sports



	Ref.	Size	Measurements	Color
	75541-20	S	28" - 33" / 71 - 84 cm	Black
	75541-21	M	33" - 37" / 84 - 94 cm	Black
	75541-22	L	37" - 41" / 94 - 104 cm	Black
	75541-23	XL	41" - 45" / 104 - 114 cm	Black
	75541-24	XXL	45" - 49" / 114 - 124 cm	Black



## Actimove® EVERYDAY SUPPORTS

With age, patients frequently suffer from chronic degenerative joints diseases, impacting how they are able to move. They are looking for stability to support their mobility.

Actimove® Everyday Supports provides medical compression that helps to reduce edema and aids pain relief. Its enduring comfort is combined in a range of reliable and durable supports.

- **Medical compression** properties provide support and stability which helps to reduce swelling and manage pain relief.
- The **unique helix design** is inspired by physiological taping and the supports are anatomically shaped for stability.
- Made from soft yarns, Actimove® Everyday Supports have special **comfort zones** for sensitive areas. Further, the products are suitable for those sensitive to latex, as this product is not made with natural rubber latex.



# Actimove® Wrist Stabilizer Carpal

Pre-shaped Metal Stay

Anatomical shape for correct positioning, full finger movement and hand dexterity

- Pain relief and healing are supported through balanced warmth and medical compression.
- Helps to manage pain by stabilizing wrist with anatomically shaped stay for correct positioning.
- Provides relief as hand can rest on palmar pad supported by rigid, angled stay.
- Full finger movement and hand dexterity from unique open design.
- Comfort and good breathability through neoprene-free performance material.
- Neoprene-free, made with COOLMAX® AIR technology.
- Suitable for those sensitive to latex, as this product is not made with natural rubber latex.
- Universal sizing.
- Can be worn left or right.
- For stock keeping, long shelf life of five years.
- For better hygiene, product or part of the product is hand washable. Always read the washing instructions on the packaging.

This product is intended for wrist support. Fields of application include:  
- Symptomatic relief of carpal tunnel syndrome, e.g., while using a computer



Ref.	Size	Measurements	Color
75714-20	Universal	5 <sup>1</sup> / <sub>2</sub> " - 8" / 14 - 20 cm	Black



# Actimove® Knee Support

Closed Patella, 2 Stays

Firm compression, added stability, durable support, functional helix design

- Firm compression to help manage pain from knee conditions.
- Added stability through two spiral stays.
- Reliable, durable support for everyday mobility.
- Anatomical shape supported by a patterned helix design for a good fit.
- Soft, smooth Motion-Comfort-Zone in the popliteal area.
- Reinforced edges for long lasting wear.
- Soft, latex-free and cotton-free yarns for enduring comfort.
- Suitable for those sensitive to latex, as this product is not made with natural rubber latex.
- Available in four sizes.
- Can be worn left or right.
- For stock keeping, long shelf life of five years.
- For better hygiene, product or part of the product is machine washable. Always read the washing instructions on the packaging.

This product is intended to provide support to the knee. Fields of application include:  
- Degenerative knee conditions  
- Overuse or repetitive use syndromes  
- Chronic knee pain

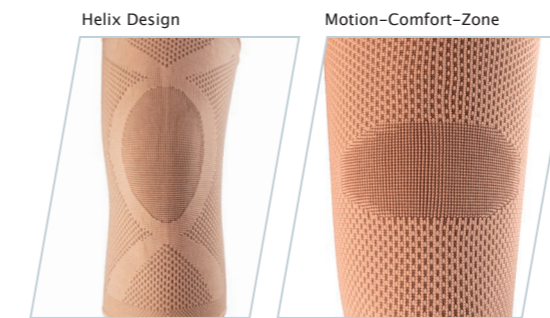

Ref.	Size	Measurements	Color
75575-28	S	12 <sup>1</sup> / <sub>4</sub> " - 14 <sup>1</sup> / <sub>4</sub> " / 31 - 36 cm	Beige
75575-29	M	14 <sup>1</sup> / <sub>4</sub> " - 16 <sup>1</sup> / <sub>4</sub> " / 36 - 41 cm	Beige
75575-30	L	16 <sup>1</sup> / <sub>4</sub> " - 18" / 41 - 46 cm	Beige
75575-31	XL	18" - 20 <sup>1</sup> / <sub>2</sub> " / 46 - 52 cm	Beige



# Actimove® Ankle Support

Firm compression, reliable, durable support for everyday mobility

- Firm compression to help manage pain from ankle conditions.
- Reliable, durable support for everyday mobility.
- Seamless anatomical shape supported by a patterned helix design for a good fit.
- Reinforced edges for long lasting wear.
- Soft, smooth Motion-Comfort-Zone in the instep.
- Soft, latex-free and cotton-free yarns for enduring comfort.
- Suitable for those sensitive to latex, as this product is not made with natural rubber latex.
- Available in four sizes.
- Can be worn left or right.
- For stock keeping, long shelf life of five years.
- For better hygiene, product or part of the product is machine washable. Always read the washing instructions on the packaging.

This product is intended to provide support/stabilization to the ankle.

Fields of application include:

- Degenerative ankle conditions
- Overuse or repetitive use syndromes
- Chronic ankle pain



Pattern Design

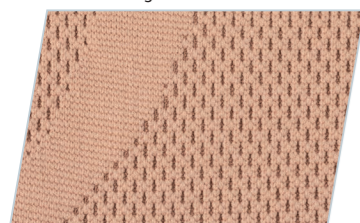

	Ref.	Size	Measurements	Color
	75608-20	S	7" - 8 <sup>3</sup> / <sub>4</sub> " / 18 - 21 cm	Beige
	75608-21	M	8 <sup>1</sup> / <sub>4</sub> " - 9 <sup>1</sup> / <sub>2</sub> " / 21 - 24 cm	Beige
	75608-22	L	9 <sup>1</sup> / <sub>2</sub> " - 10 <sup>3</sup> / <sub>4</sub> " / 24 - 27 cm	Beige
	75608-23	XL	10 <sup>3</sup> / <sub>4</sub> " - 11 <sup>3</sup> / <sub>4</sub> " / 27 - 30 cm	Beige

## Actimove® ARTHRITIS CARE

Elderly people suffering from chronic, painful osteoarthritis or rheumatoid arthritis are on a quest to find lasting pain-relief<sup>1</sup> to help them live their daily lives.

Actimove® Arthritis Care supports aid pain relief and increase joint mobility through soothing warmth and compression.

- Actimove® Arthritis Care are made with **special ceramic yarns** which retain and reflect body heat.
- **Medical compression** properties provide support and stability, helping to reduce swelling, increase joint mobility and help to manage pain.
- The **skin friendly materials** are soft, comfortable and suitable for those sensitive to latex, as these products are not made with natural rubber latex.

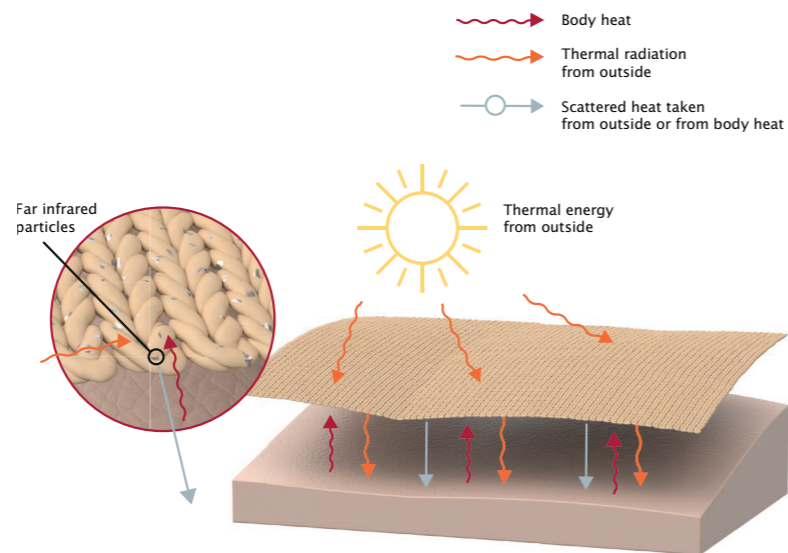

<sup>1</sup> Essity Internal Shopper Study

# Actimove® Wrist Support

Soothing warmth for wrists from heat-retaining ceramic fibers

- Helps to relieve pain through soothing warmth provided by the special ceramic fibers that retain and reflect body heat.
- Improved mobility as swelling is reduced through light, comfortable compression provided by the four-way stretch material.
- For faster return to daily activities, therapeutic warming promotes circulation around the wrist.
- Suitable for those sensitive to latex, as this product is not made with natural rubber latex.
- Available in four sizes.
- Can be worn left or right.
- For stock keeping, long shelf life of five years.
- For better hygiene, product or part of the product is machine washable. Always read the washing instructions on the packaging.

This product is intended to provide support and therapeutic warmth to the wrist.

Fields of application include:

- Painful arthritis of the wrist joint



	Ref.	Size	Measurements	Color
	75779-20	S	4 <sup>3</sup> / <sub>4</sub> " - 6" / 12 - 15 cm	Beige
	75779-21	M	6" - 6 <sup>3</sup> / <sub>4</sub> " / 15 - 17 cm	Beige
	75779-22	L	6 <sup>3</sup> / <sub>4</sub> " - 7 <sup>1</sup> / <sub>2</sub> " / 17 - 19 cm	Beige
	75779-23	XL	7 <sup>1</sup> / <sub>2</sub> " - 8 <sup>1</sup> / <sub>4</sub> " / 19 - 21 cm	Beige

# Actimove® Arthritis Gloves

Balanced warmth and medical compression, comfortable from outer seams

- Pain relief and healing are supported through balanced warmth and medical compression.
- Comfort and good breathability through neoprene-free performance material.
- Provides light compression to help reduce swelling for improved finger and hand mobility.
- Comfortable to wear because of premium soft material and outside seams.
- Suitable for those sensitive to latex, as this product is not made with natural rubber latex.
- Available in four sizes.
- Available as a pair.
- For stock keeping, long shelf life of five years.
- For better hygiene, product or part of the product is hand washable. Always read the washing instructions on the packaging.

This product is intended for arthritis of the hand.

Fields of application include:

- Arthritis
- Aching fingers and hands
- Overuse or repetitive use syndromes



Outside Seams

Inside of Glove



	Ref.	Size	Measurements	Color
	75783-20	S	7" - 8" / 18 - 20 cm	Beige
	75783-21	M	8" - 9 <sup>1</sup> / <sub>4</sub> " / 20 - 23.5 cm	Beige
	75783-22	L	9 <sup>1</sup> / <sub>4</sub> " - 10 <sup>1</sup> / <sub>2</sub> " / 23.5 - 27 cm	Beige
	75783-23	XL	10 <sup>1</sup> / <sub>2</sub> " - 11 <sup>3</sup> / <sub>4</sub> " / 27 - 30 cm	Beige



## Actimove® Knee Support

Soothing warmth for knees from heat-retaining ceramic fibers

- Helps to relieve pain through soothing warmth provided by the special ceramic fibers that retain and reflect body heat.
- Improved mobility as swelling is reduced through light, comfortable compression provided by the four-way stretch material.
- For faster return to daily activities, therapeutic warming promotes circulation around the knee.
- For more comfort during joint movement, higher stretch at specially designed flex-zone.
- Proper placement of the support on the joint is supported by the flex zone design.
- Suitable for those sensitive to latex, as this product is not made with natural rubber latex.
- Available in five sizes.
- Can be worn left or right.
- For stock keeping, long shelf life of five years.
- For better hygiene, product or part of the product is machine washable. Always read the washing instructions on the packaging.

This product is intended to provide support and therapeutic warmth to the knee.

Fields of application include:

- Painful arthritis of the knee joint



	Ref.	Size	Measurements	Color
	75781-20	S	11" - 13" / 28 - 33 cm	Beige
	75781-21	M	13" - 15" / 33 - 38 cm	Beige
	75781-22	L	15" - 17" / 38 - 43 cm	Beige
	75781-23	XL	17" - 19 <sup>1</sup> / <sub>4</sub> " / 43 - 49 cm	Beige
	75781-24	XXL	19 <sup>1</sup> / <sub>4</sub> " - 22" / 49 - 56 cm	Beige

## Actimove® PROFESSIONAL LINE

Solutions to help improve the life of your patients supporting you in your everyday work life, the Actimove Professional Line is designed to support the treatment of acute injuries, post-op use and rehabilitation of chronic, orthopedic issues.

A shopper study<sup>1</sup> has shown what the patients' concerns are. The most important one is pain relief – followed by quality and comfort.

### Pain Relief

Actimove Professional Line products provide the right functionality based on biomechanics to help support patients' pain relief.

### Quality

Actimove Professional Line products are tested thoroughly and constantly updated for a high standard of quality and longevity.

### Comfort

Well-fitting products made from carefully chosen materials, paired with the correct sizing ensure patient comfort when it is most needed.

The line comprises a great range of braces and supports – for most needs, ages, and body parts. Actimove pledges to improve its offering further and further through research and innovation. All to give you assurance and help manage your patients' pain and support their movement.

<sup>1</sup> Essity shopper study, data on file



# WRIST & THUMB



# Actimove® Rhizo Forte

## Thumb Orthosis

The patented brace restricting thumb movement while maintaining the functionality of the hand during daily activities

- Clinically proven to help alleviate pain arising from osteoarthritis of the thumb.<sup>1</sup>
- Supports pain relief by placing the thumb in a functional position and immobilizing the carpometacarpal (CMC) and the first metacarpophalangeal (MCP1) joints.
- Usage of Actimove Rhizo Forte may help to reduce intake of pain medication.<sup>1</sup>
- A study has shown that Actimove Rhizo Forte can help decrease sleep disturbances often observed in symptomatic osteoarthritis of the thumb.<sup>1</sup>
- Improved design for optimized fit and comfort around the thumb.
- For everyday wear, as wrist and fingers are free to move while the thumb is effectively restricted.
- Provides excellent fit and high comfort by customizing anatomical shape.
- Individually adjustable to the palm by molding the aluminum core.
- Maximum wearing comfort thanks to the open, low-profile design.
- Measure the palm width for the correct size.
- Easy to close with one hand using hook & loop straps.
- For easy daily hygiene: Water-resistant brace dries quickly after hand washing.
- This orthosis can even be worn when in contact with food.<sup>2</sup>
- Suitable for those sensitive to latex, as this product is not made with natural rubber latex.
- Protected by patent, see [www.essity.com/patents](http://www.essity.com/patents).
- Available in three sizes.
- For stock keeping, long shelf life of five years.
- For better hygiene, product or part of the product is hand washable. Always read the washing instructions on the packaging.

This product is intended to provide immobilization of the thumb.

Fields of application include:

- Thumb osteoarthritis
- Rheumatoid arthritis of the thumb
- Ulnar collateral ligament injuries of the MCP 1 joint (e.g., skier's thumb)
- Instability of the CMC joint
- Soft tissue injuries (sprains)
- Traumatic thumb dislocation
- Ligament instabilities
- Postsurgical and nonsurgical treatment



	Ref.		Size	Measurements	Color	Unit
	Left	Right				
	76238-01	76238-00	S	6.8 – 8 cm 2 3/4" – 3"	Gray	1
	76238-03	76238-02	M	8 – 9 cm 3" – 3 1/2"	Gray	1
	76238-05	76238-04	L	9 – 10 cm 3 1/2" – 4"	Gray	1

<sup>1</sup> Essity/BSN medical GmbH, 2021, data on file, submitted for publication

<sup>2</sup> SGS group, 2021, data on file

# Actimove® Manus Air

## Stabilizing Fracture Wrist Brace

Our first ready-to-wear fracture wrist brace which is effective by immobilizing the wrist and time-saving through its unique design

- Supports fracture healing by immobilizing the wrist through the anatomically shaped aluminum splint.
- Supports pain relief by offering secure stability through a 3-strap system and an anatomically shaped aluminum splint.
- High comfort and discreet wear due to the low-profile, open, and light-weight design.
- Ease of application slip-on design even with the non-dominant hand.
- For improved hand hygiene, the wrist brace is water resistant and can be worn during hand washing and/or showering.
- Allows for easier wound inspection as brace leaves typical incision sites for Distal Radius Fracture surgery uncovered due to the open design.
- High patient comfort during examination or change of wound dressings minimizing unnecessary wrist movements and associated pain thanks to the unique open design.
- Maintains hand function as design allows for full finger and thumb range of motion.
- Suitable for those sensitive to latex, as this product is not made with natural rubber latex.
- Can be worn even in contact with food thanks to food-grade material.
- Provides customizable fit by allowing the healthcare professional or other person with expertise to adjust the aluminum core.
- Time-saving alternative to thermoplastic splints, offering a customized post-cast brace applied in minutes.
- Versatile use in fracture treatments suitable for acute stage in stable non-displaced fractures, post-op use or at post-splint stage, and post-cast stabilization.

This product is intended to provide support to the arm, elbow and shoulder.

**Fields of application include:**

- Conservative treatment of stable, non-displaced distal radius fractures
- Post-operative stabilization of plated distal radius/ulna fractures
- Post-traumatic stabilization after cast removal
- Wrist sprains
- Tendovaginitis (US: Tendinitis)
- Carpal tunnel syndrome (CTS)
- Arthritis of the wrist (osteoarthritis or rheumatoid arthritis)



Time-efficient as can be applied up to 50% faster than a circumferential thermoplastic splint thanks to the ready-to-wear open construction.

Helps to mitigate the financial burden of fracture-related infection as wound can be easily monitored thanks to the open design.

Hygienic as can be worn during hand washing and/or showering and even in contact with food thanks to the water-resistant, food-grade material.

Helps patients to carry on with activities of daily living and their work as brace design maintains hand function with full finger and thumb range of motion.

	Ref.		Size	Measurements	Color
	Left	Right			
	65005-00	65005-03	S	6.8 - 8 cm 2 <sup>3</sup> / <sub>4</sub> " - 3"	Black
	65005-01	65005-04	M	8 - 9 cm 3" - 3 <sup>1</sup> / <sub>2</sub> "	
	65005-02	65005-05	L	9 - 10 cm 3 <sup>1</sup> / <sub>2</sub> " - 4"	

# Actimove® ManuMotion

## Wrist Support

**Anatomically shaped wrist support featuring 3D knitting technology and award-winning helix design for medical compression providing stability with integrated pressure pad to help pain relief**

- Supports pain relief and healing by stabilizing the wrist in a physiological position through the anatomically shaped, thermoplastic stay and pressure pad.
- Helps to support pain relief by stabilizing the wrist through the 3D flat-knitted structure providing compression.
- Added stability thanks to the circumferential, inelastic wrist band that is adjustable and fully removable.
- Contributes to healing by reducing edema, effusions, and hematoma, thanks to the anatomically shaped dorsal pressure pad for a targeted intermittent massage effect.
- For more wearing comfort especially designed soft, smooth Motion-Comfort-Zone helps to prevent wrinkling in the thumb opening area and allows it to move.
- Prevents further pressure peaks on bony prominences thanks to the cut-outs in the dorsal pressure pad.
- Anti-slip for pressure-reduced distal and proximal cuffs without an elastic band preventing constriction.
- Seamless look thanks to the fusion technology used for the integration of the pressure pad.
- Easily removable stay placed in a pocket using seamless fusion technology for fixation on the outer side of the wrist.
- Skin-friendly and breathable 3D knit using OEKO-TEX® certified combination of yarn materials.<sup>1</sup>
- Easier application thanks to the included donning aid.
- Suitable for those sensitive to latex, as this product is not made with natural rubber latex.
- Available in six sizes
- For stock keeping, long shelf life of five years.
- For better hygiene, product or part of the product is machine washable. Always read the washing instructions on the packaging.

**This product is intended for wrist support.**

**Fields of application include:**

- Painful arthrosis
- Rheumatoid arthritis of the wrist
- Distortions (sprains)
- Tendovaginitis
- Tendon injuries
- Ligament injuries
- Soft tissue injuries
- Posttraumatic irritations
- Postoperative use



Donning Aid included.

	Ref.		Size	Measurements	Color	Unit
	Left	Right				
	73497-42	73497-12	XS	14 - 15 cm 5 <sup>1/2</sup> " - 6"	White	1
	73497-43	73497-13	S	15 - 16 cm 6" - 6 <sup>1/4</sup> "	White	1
	73497-44	73497-14	M	16 - 17 cm 6 <sup>1/4</sup> " - 6 <sup>3/4</sup> "	White	1
	73497-45	73497-15	L	17 - 18 cm 6 <sup>3/4</sup> " - 7"	White	1
	73497-46	73497-16	XL	18 - 19 cm 7" - 7 <sup>1/2</sup> "	White	1

<sup>1</sup> Tested for harmful substances according to OEKO-TEX® Standard 100. OEKO-TEX® certificate: 13.HTR.25112

# Actimove® Manus Forte

## Wrist Brace

### Highly comfortable, reliable brace for the immobilization of the wrist

- Supports pain relief by strongly and securely stabilizing the wrist in a functional position, preventing flexion and extension through the combination of the rigid aluminum stay, and the wide, circular, and inelastic middle strap.
- Suitable for everyday wear, the secure-fit-design allows the fingers to move freely while fixating the wrist.
- High wearing comfort thanks to the wide thumb opening with soft edges, allowing for full finger dexterity.
- Easy to apply, handle and remove with one hand due to the tubular slip-on design.
- Additional overall stabilization of the wrist through two stays on the back of the hand.
- Individual fit by molding the anatomically shaped aluminum stay as required.
- Also usable in the late rehabilitation phase, when less stability is needed, by removing the palmar stay.
- For ease of use special security hook & loop closure to prevent straps from slipping out of the buckles.
- High wearing comfort and natural skin climate thanks to the soft, breathable spacer fabric.
- Suitable for those sensitive to latex, as this product is not made with natural rubber latex.
- Available in three sizes.
- Available for left and right.
- For stock keeping, long shelf life of five years.
- For better hygiene, product or part of the product is hand or machine washable. Always read the washing instructions on the packaging.

The product is intended to provide stabilization/support to the wrist.

Fields of application include:

- Inflammatory diseases (e.g. De Quervain's tendosynovitis, tendovaginitis)
- Sprains and strains
- Soft tissue injuries
- Osteoarthritis (OA)
- Rheumatoid arthritis
- Post-operative care
- Care after cast removal



	Ref.		Size	Measurements	Color	Unit
	Left	Right				
	73482-02	73482-01	XS	≤ 14 cm ≤ 5 1/2"	Black	1
	73482-04	73482-03	S/M	14 - 19 cm 5 1/2" - 7 1/2"	Black	1
	73482-06	73482-05	L/XL	19 - 23 cm 7 1/2" - 9"	Black	1

# Actimove® Manus Forte Plus

## Wrist & Thumb Brace

Highly comfortable, reliable brace for the immobilization of the wrist and thumb

- Supports pain relief by strongly and securely stabilizing the wrist in a functional position, preventing flexion and extension through the combination of the rigid aluminum stay, and the wide, circular and inelastic middle strap.
- Helps to alleviate pain as the thumb is immobilized by the rigid aluminum spica stay.
- Suitable for everyday wear, the secure-fit-design allows the fingers to move freely while fixating the wrist.
- Easy to apply, handle and remove with one hand due to the tubular slip-on design and the simple to adjust thumb closure.
- Additional overall stabilization of the wrist through two stays on the back of the hand.
- Individual fit by molding the anatomically shaped aluminum stay as required.
- Also usable in the late rehabilitation phase, when less stability is needed, by removing the palmar stay.
- For ease of use special security hook & loop closure to prevent straps from slipping out of the buckles.
- High wearing comfort and natural skin climate thanks to the soft, breathable spacer fabric.
- Suitable for those sensitive to latex, as this product is not made with natural rubber latex.
- Available in three sizes.
- Available for left and right.
- For stock keeping, long shelf life of five years.
- For better hygiene, product or part of the product is machine washable. Always read the washing instructions on the packaging.

The product is intended to provide stabilization/support to the wrist.

Fields of application include:

- Osteoarthritis of the wrist and thumb (e.g., rhizarthrosis)
- Soft tissue injuries of the wrist and thumb (e.g. from repetitive motion activities, like texting or gaming)
- Skier's thumb
- Sprains and strains
- Rheumatoid arthritis
- Post-operative care
- Post-traumatic care
- Inflammatory diseases (e.g., De Quervain's tendosynovitis, tendovaginitis)
- Care after cast removal
- Carpal tunnel syndrome (CTS)



	Ref.		Size	Measurements	Color	Unit
	Left	Right				
	73496-33	73496-03	XS	≤ 14 cm ≤ 5 1/2"	Black	1
	73496-34	73496-04	S/M	14 - 19 cm 5 1/2" - 7 1/2"	Black	1
	73496-36	73496-06	L/XL	19 - 23 cm 7 1/2" - 9"	Black	1

# ELBOW



# Actimove® EpiMotion

## Elbow Support

Anatomically shaped elbow support featuring 3D knitting technology and award-winning Helix design for gradient medical compression, providing stability, and integrated pressure pads to help pain relief

- Helps pain relief, as the support offers stability through the anatomical shape and the 3D flat-knitted structure, providing gradient medical compression.
- Contributes to pain relief and healing by reducing edema, through targeted pressure and an intermittent massage effect thanks to the two anatomically shaped ulnar and radial pressure pads.
- Prevents further pressure peaks on bony prominences thanks to the epicondyle cut-outs in the pressure pads.
- For more wearing comfort especially designed soft Motion-Comfort-Zone smooth fit in the elbow crease.
- Anti-slip for pressure-reduced distal and proximal cuffs without an elastic band preventing constriction.
- Seamless look thanks to the fusion technology used for the integration of the pressure pads.
- Skin-friendly and breathable 3D knit using OEKO-TEX® certified combination of yarn materials.<sup>1</sup>
- Suitable for those sensitive to latex, as this product is not made with natural rubber latex.
- Available in seven sizes.
- For stock keeping, long shelf life of five years.
- For better hygiene, product or part of the product is machine washable. Always read the washing instructions on the packaging.

This product is intended for elbow support.

Fields of application include:

- Tennis elbow (lateral epicondylitis)
- Golfers Elbow (medial epicondylitis)
- Arthritis (joint inflammation)
- Arthrosis
- Rheumatoid joint effusion
- Bursitis olecrani (student's elbow)
- Insertion tendopathy of the triceps brachii
- Posttraumatic irritations
- Postoperative use



	Ref.	Size	Measurements	Color	Unit
	73477-12	XS	19 – 21 cm 7 1/2" – 8 1/4"	White	1
	73477-13	S	21 – 23 cm 8 1/4" – 9"	White	1
	73477-14	M	23 – 25 cm 9" – 9 3/4"	White	1
	73477-15	L	25 – 27 cm 9 3/4" – 10 1/2"	White	1
	73477-16	XL	27 – 29 cm 10 1/2" – 11 1/2"	White	1
	73477-17	XXL	29 – 31 cm 11 1/2" – 12 1/4"	White	1

<sup>1</sup> Tested for harmful substances according to OEKO-TEX® Standard 100. OEKO-TEX® certificate: 13.HTR.25112

# SHOULDER



# Actimove® Sling Comfort

## Arm Sling – Dispenser Box

### Customizable, comfort arm sling for multi-application in a practical dispenser box

- Customizable support for multi-application in a practical dispenser box with integrated measuring tool.
- Provides support to the arm, elbow and shoulder by securely holding the forearm in a flexed position.
- Good patient wearing comfort due to the complete, open construction and reduced neck pressure through the 5.5 cm / 2 1/4" wide and stable sling replacing a separate neck pad.
- Quick and easy to apply or remove with one hand thanks to the hook and loop Y-tabs.
- Suitable for those sensitive to latex, as this product is not made with natural rubber latex.
- For stock keeping, long shelf life of five years.
- For better hygiene, product or part of the product is machine washable. Always read the washing instructions on the packaging.

This product is intended to provide support to the arm, elbow and shoulder.

Fields of application include:

- Postoperative use (e.g. after rotator cuff rupture)
- Fracture management (e.g. clavicle, scapular, humeral, and greater tuberosity fractures)
- Joint distortions (sprains) and dislocations (e.g. acromioclavicular & sternoclavicular dislocations, shoulder luxation)
- Inflammatory diseases (e.g. calcific tendinitis of the rotator cuff)
- Minor instability of the shoulder (e.g. dorsal instability)
- Support for hemiplegic patients
- Support while wearing a cast or splint
- Temporary arm stabilization in emergency/paramedic care



Ref.	Size	Measurements	Color	Unit
72859-18	Univ.	5.5 cm x 12 m 2 1/4 in x 13 yds	Blue	2 Rolls

### Y-Tab for Sling Comfort

Ref.	Size	Color	Unit
73466-00	Universal	Black	14



# Actimove® Mitella

## Arm Sling

**Shoulder, elbow and arm support to limit the range of motion, keeping the elbow in a flexed position.**

- Helps to relieve pain by stabilizing the shoulder joint and keeping the flexed elbow in a pocket which limits the range of motion.
- Secure to wear, as the hand positioning through the thumb loop limits the rotation of the forearm, keeping it safe in the pocket while still allowing full finger movement.
- Easy to apply and remove and adjustable with one hand thanks to the hook-and-loop Y-Tabs.
- Patient comfort thanks to the breathable pocket material.
- Convenient for follow up exams, as product does not need to be removed prior to taking x-rays.
- Suitable for those sensitive to latex, as this product is not made with natural rubber latex.
- Available in four sizes.
- For stock keeping, long shelf life of five years.
- For better hygiene, product or part of the product is machine washable. Always read the washing instructions on the packaging.

**This product is intended to provide support to the arm, elbow and shoulder.**

**Fields of application include:**

- Postoperative use (e.g. after rotator cuff rupture)
- Fracture management (e.g. clavicle, scapular, humeral, and greater tuberosity fractures)
- Joint distortions (sprains) and dislocations
- Inflammatory diseases (e.g. calcific tendinitis of the rotator cuff)
- Minor instability of the shoulder (e.g. dorsal instability)
- Support for hemiplegic patients
- Support while wearing a cast or splint
- Temporary arm stabilization in emergency/paramedic care



	Ref.	Size	Measurements	Color	Unit
	72819-57	S	< 37cm / < 14 1/2"	Blue	1
	72819-58	M	37 - 40 cm / 14 1/2" - 15 3/4"	Blue	1
	72819-59	L	40 - 43 cm / 15 3/4" - 17"	Blue	1
	72819-60	XL	> 43 cm / > 17"	Blue	1

# Actimove® Mitella Comfort

## Comfort Arm Sling

**Comfort shoulder, elbow and arm support limiting the range of motion in the shoulder and elbow joint and providing rest in a flexed elbow position**

- Easy to apply, adjust or remove with one hand thanks to the hook and loop Y-Tabs and open-and-close pocket design.
- For good patient wearing comfort, reduced neck pressure though the 5.5 cm wide and stable sling replacing a separate neck pad.
- Helps to relieve pain by stabilizing the shoulder joint and keeping the flexed elbow in a pocket which limits the range of motion.
- Secure to wear, as the hand positioning through the thumb loop limits the rotation of the forearm, keeping it safe in the pocket while still allowing full finger movement.
- Patient comfort thanks to the breathable pocket material.
- Convenient for follow up exams, as product does not to be removed prior to taking x-rays.
- Suitable for those sensitive to latex, as this product is not made with natural rubber latex.
- Available in four sizes.
- For stock keeping, long shelf life of five years.
- For better hygiene, product or part of the product is machine washable. Always read the washing instructions on the packaging.

**This product is intended to provide support to the arm, elbow and shoulder.**

### Fields of application include:

- Postoperative use (e.g. after rotator cuff rupture)
- Fracture management (e.g. clavicle, scapular, humeral, and greater tuberosity fractures)
- Joint distortions (sprains) and dislocations (e.g. acromioclavicular & sternoclavicular dislocations, shoulder luxation)
- Inflammatory diseases (e.g. calcific tendinitis of the rotator cuff)
- Minor instability of the shoulder (e.g. dorsal instability)
- Support for hemiplegic patients
- Support while wearing a cast or splint
- Temporary arm stabilization in emergency/paramedic care



	Ref.	Size	Measurements	Color	Unit
	72819-61	S	<37 cm <14 <sup>1/2</sup> "	Blue	1
	72819-62	M	37 - 40 cm 14 <sup>1/2</sup> " - 15 <sup>3/4</sup> "	Blue	1
	72819-63	L	40 - 43 cm 15 <sup>3/4</sup> " - 17"	Blue	1
	72819-64	XL	>43 cm >17"	Blue	1

# Actimove® Umerus

## Shoulder Immobilizer

### Shoulder and upper arm immobilizer for movement limitation in the shoulder joint.

- Helps to relieve pain by immobilizing the shoulder joint and limiting the abduction, extension and external rotation of the humerus.
- Improved shoulder stabilization through the waist strap.
- Secure, as the hand positioning through the thumb loop limits the rotation of the forearm, keeping it safe in the pocket while still allowing full finger movement.
- For an individual fit, suitable for most patients thanks to the adjustable waist and shoulder straps.
- Easy to apply and remove and adjustable with one hand thanks to the hook and loop Y-Tabs.
- Patient comfort thanks to the breathable pocket material.
- Convenient for follow up exams, as product does not need to be removed prior to taking x-rays.
- Suitable for those sensitive to latex, as this product is not made with natural rubber latex.
- Available in five sizes.
- For stock keeping, long shelf life of five years.
- For better hygiene, product or part of the product is machine washable. Always read the washing instructions on the packaging.

This product is intended to provide support to the arm, elbow and shoulder.

#### Fields of application include:

- Postoperative use (e.g. after rotator cuff rupture)
- Fracture management (e.g. clavicle, scapular, humeral, and greater tuberosity fractures)
- Joint distortions (sprains) and dislocations (e.g. acromioclavicular & sternoclavicular dislocations, shoulder luxation)
- Inflammatory diseases (e.g. calcific tendinitis of the rotator cuff)
- Minor instability of the shoulder (e.g. dorsal instability)
- Support for hemiplegic patients
- Support while wearing a cast or splint
- Temporary arm stabilization in emergency/paramedic care

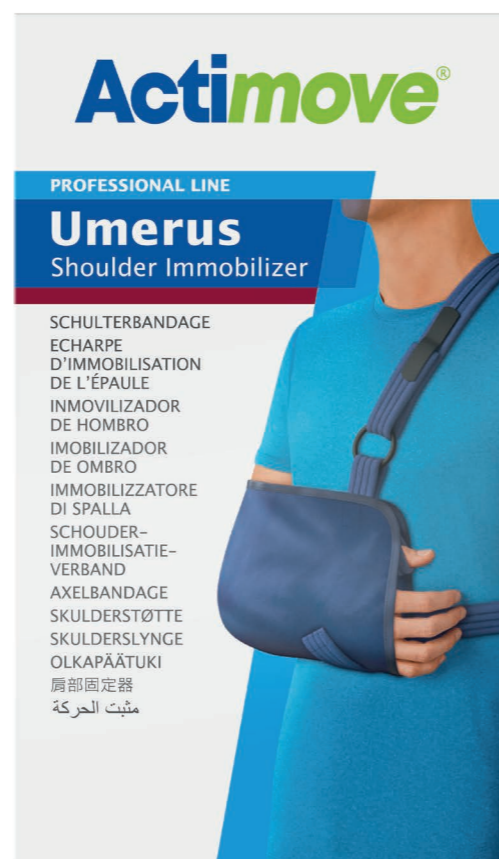

	Ref.	Size	Measurements	Color	Unit
	72819-65	S	< 37cm / < 14 1/2"	Blue	1
	72819-66	M	37 - 40 cm / 14 1/2" - 15 3/4"	Blue	1
	72819-67	L	40 - 43 cm / 15 3/4" - 17"	Blue	1
	72819-68	XL	> 43 cm / > 17"	Blue	1

# Actimove® Umerus Comfort

## Comfort Shoulder Immobilizer

### Comfort shoulder and upper arm immobilizer for limited movements in the shoulder joint

- Helps to relieve pain by immobilizing the shoulder joint and limiting the abduction, extension and external rotation of the humerus.
- Improved shoulder stabilization through the waist strap.
- Secure, as the hand positioning through the thumb loop limits the rotation of the forearm, keeping it safe in the pocket while still allowing full finger movement.
- For an individual fit, suitable for most patients thanks to the adjustable waist and shoulder straps.
- Easy to apply, adjust or remove with one hand thanks to the hook and loop Y-Tabs and open-and-close pocket design.
- For good patient wearing comfort, reduced neck pressure though the 5.5cm wide and stable sling replacing a separate neck pad.
- Patient comfort thanks to the breathable pocket material.
- Convenient for follow up exams, as product does not to be removed prior to taking x-rays.
- Suitable for those sensitive to latex, as this product is not made with natural rubber latex.
- Available in five sizes.
- For stock keeping, long shelf life of five years.
- For better hygiene, product or part of the product is machine washable. Always read the washing instructions on the packaging.

This product is intended to provide support to the arm, elbow and shoulder.

#### Fields of application include:

- Postoperative use (e.g. after rotator cuff rupture)
- Fracture management (e.g. clavicle, scapular, humeral, and greater tuberosity fractures)
- Joint distortions (sprains) and dislocations (e.g. acromioclavicular & sternoclavicular dislocations, shoulder luxation)
- Inflammatory diseases (e.g. calcific tendinitis of the rotator cuff)
- Minor instability of the shoulder (e.g. dorsal instability)
- Support for hemiplegic patients
- Support while wearing a cast or splint
- Temporary arm stabilization in emergency/paramedic care



	Ref.	Size	Measurements	Color	Unit
	72819-94	XS	<33 cm <13"	Blue	1
	72819-39	S	33 - 37 cm 13" - 14 <sup>1/2</sup> "	Blue	1
	72819-40	M	37 - 40 cm 14 <sup>1/2</sup> " - 15 <sup>3/4</sup> "	Blue	1
	72819-41	L	40 - 43 cm 15 <sup>3/4</sup> " - 17"	Blue	1
	72819-42	XL	>43 cm >17"	Blue	1

# Actimove® Shoulder Abduction Sling

## Shoulder Immobilizer

**Comfortable shoulder immobilizer that puts the upper arm in a predefined abduction position**

- Provides relief and helps to manage pain through immobilization of the shoulder while the upper arm is positioned in predefined abduction (around 15°).
- Helps to increase muscle strength following shoulder surgery thanks to the squeeze ball that enables hand and wrist exercises.
- Easy to apply and to remove, even with one hand, thanks to the stable closure system with two snap-lock buckles."
- Secure and tailored fit for most patients through the extra-long, adjustable waist strap.
- Increased comfort thanks to the additional, positionable pad to reduce neck pressure.
- Good wearing comfort thanks to the breathable, perforated inner pocket material and soft outer materials.
- Clothes are protected through the soft, supple and color fast material.
- Convenient for medical check-ups due to its radiolucency.
- Suitable for those sensitive to latex, as this product is not made with natural rubber latex.
- Universal, right or left fit, eliminates the need for excess stock.
- Available in four sizes.
- For stock keeping, long shelf life of five years.
- For better hygiene, product or part of the product is machine washable. Always read the washing instructions on the packaging.

**This product is intended to provide support to the arm, elbow and shoulder.**

**Fields of application include:**

- Minor instability of the shoulder (e.g., dorsal instability)
- Postoperative use (e.g., after rotator cuff rupture)
- Joint dislocations (e.g., shoulder luxation)

Please contact your healthcare professional if you are unsure whether the product is appropriate for you.



	Ref.	Size	Measurements	Color
	73446-04	S	<37 cm <14 1/2"	Blue
	73446-05	M	37 - 40 cm 14 1/2" - 15 3/4"	Blue
	73446-06	L	40 - 43 cm 15 3/4" - 17"	Blue
	73446-07	XL	>43 cm >17"	Blue



KNEE



# Actimove® GenuMotion

## Knee Support

Anatomically shaped knee support featuring 3D knitting technology and award-winning Helix design for gradient medical compression, providing stability through stays, and integrated pressure pad to help pain relief

- Helps pain relief, as the support offers stability through the anatomical shape and the 3D flat-knitted structure, providing gradient medical compression and a secure fit.
- Contributes to pain relief and healing by reducing edema, through targeted pressure and an intermittent massage effect thanks to the anatomically shaped circular pressure pad.
- For more wearing comfort especially designed soft, smooth Motion-Comfort-Zone that helps to prevent wrinkling in the popliteal area.
- Anti-slip for pressure-reduced distal and proximal cuffs without an elastic band preventing constriction.
- Added stabilization with great mobility thanks to the lateral spiral stays.
- Skin-friendly and breathable 3D knit using OEKO-TEX® certified combination of yarn materials.<sup>1</sup>
- Seamless look thanks to the fusion technology used for the integration of the pressure pad and stays.
- Suitable for those sensitive to latex, as this product is not made with natural rubber latex.
- Available in 15 sizes, including six plus sizes.
- For stock keeping, long shelf life of five years.
- For better hygiene, product or part of the product is machine washable. Always read the washing instructions on the packaging.

The product is intended to stabilize the knee.

### Fields of application include:

- Chondromalacia with or without recurrent joint swellings
- Gonarthrosis
- Arthritis
- Posttraumatic irritations
- Postoperative use
- Minor instabilities of the knee joint
- Minor meniscal damages
- Tendomyopathy



	Ref.	Size	Measurements		Color	Unit
			Above Knee	Below Knee		
	73468-11	XS	38 - 41 cm 15" - 16 <sup>1</sup> / <sub>8</sub> "	28 - 31 cm 11" - 12 <sup>1</sup> / <sub>4</sub> "	White	1
	73468-12	S	41 - 44 cm 16 <sup>1</sup> / <sub>8</sub> " - 17 <sup>3</sup> / <sub>8</sub> "	31 - 34 cm 12 <sup>1</sup> / <sub>4</sub> " - 13 <sup>3</sup> / <sub>8</sub> "	White	1
	73468-13	M	44 - 47 cm 17 <sup>3</sup> / <sub>8</sub> " - 18 <sup>1</sup> / <sub>2</sub> "	34 - 37 cm 13 <sup>3</sup> / <sub>8</sub> " - 14 <sup>5</sup> / <sub>8</sub> "	White	1
	73468-14	L	47 - 50 cm 18 <sup>1</sup> / <sub>2</sub> " - 19 <sup>3</sup> / <sub>4</sub> "	37 - 40 cm 14 <sup>5</sup> / <sub>8</sub> " - 15 <sup>3</sup> / <sub>4</sub> "	White	1
	73468-15	XL	50 - 53 cm 19 <sup>3</sup> / <sub>4</sub> " - 20 <sup>7</sup> / <sub>8</sub> "	40 - 43 cm 15 <sup>3</sup> / <sub>4</sub> " - 17"	White	1
	73468-16	XXL	53 - 56 cm 20 <sup>7</sup> / <sub>8</sub> " - 22"	43 - 46 cm 17" - 18 <sup>1</sup> / <sub>8</sub> "	White	1

<sup>1</sup> Tested for harmful substances according to OEKO-TEX® Standard 100. OEKO-TEX® certificate: 13.HTR.25112

# Actimove® Post-OP ROM Knee Brace

## Adjustable Knee Brace

Secure, versatile knee immobilizer with adjustable range of motion

- Secure immobilization due to the telescopic hinge bars combined with hook-and-loop strap closing system.
- Versatile, can be used post-injury, post-operatively and throughout rehabilitation.
- For a faster application, the hinge offers quick lock keys to keep the knee at 0°, 15° and 30°.
- To limit knee movement more precisely, the range of motion can be set in flexion from -10° to 120° and extension from -10° to 90° in increments of 10°.
- For therapeutic security, range-of-motion settings selected by the HCP are fixed thanks to the hinge locking system.
- Individual fit as telescopic hinge bars can be extended from 44.5 cm – 66 cm / 17.5" – 26" to fit most patients.
- Easy to apply thanks to the hook and loop buckle close system.
- Comfortable to wear thanks to the lightweight, open design and breathable materials.
- Suitable for those sensitive to latex as not made with natural rubber latex.
- Can be worn left or right.
- For low stock keeping, comes in one universal size.



This product is intended for post-operative use after knee procedures.

Fields of application include:

- ACL, PCL, MCL, LCL injuries
- Tibial plateau fractures
- Osteochondral repairs
- Meniscal repairs
- Patella tendon repairs
- Condylar fractures
- Sprains or strains of the knee
- HTOs (High Tibial Osteotomy)

	Ref.	Size	Measurements			Color
			Product Height	Circumferences Thigh	Circumferences Calf	
	76278-58	Universal	44.5 – 66 cm 17.5" – 26"	30 – 65 cm 11 <sup>7</sup> / <sub>8</sub> " – 25 <sup>2</sup> / <sub>3</sub> "	25 – 55 cm 9 <sup>7</sup> / <sub>8</sub> " – 21 <sup>2</sup> / <sub>3</sub> "	Blue

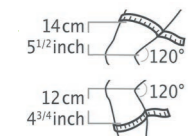

# Actimove® Genu Tri-Panel

## Knee Immobilizer

Comfortable knee immobilizer with positionable lateral side panels and an anatomically pre-shaped posterior stay for an enhanced fit

- Helps to relieve pain by immobilizing the knee through the pre-shaped posterior stay and the two positionable lateral side panels with stays.
- Comfortable wear thanks to the lightweight, slim design.
- Individual fit due to adjustable side panels that can be angled to suit a wide range of sizes and shapes.
- Enhanced patient comfort through cushioning foam material covered with terry cloth lining.
- Enhanced fit through the anatomically preshaped posterior stay.
- Easy application and removal due to hook-and-loop closure system with D-Rings.
- Suitable for those sensitive to latex, as this product is not made with natural rubber latex.
- For better hygiene, after removal of aluminum stays, product or part of the product is machine washable. Always read the washing instructions on the packaging.



This product is intended to stabilize/immobilize the knee.

Fields of application include:

- Post-operative knee support (e.g., after ligament repairs)
- Post-traumatic knee conditions (e.g., meniscal injuries, patella luxation)
- Post-arthroscopic treatment

	Ref.	Size	Measurements		Color
			Leg Height	Above Knee	
	72819-14	A1-S	50 cm 20"	< 64 cm < 25"	Blue
	72819-15	A2-L		> 64 cm > 25"	Blue
	72819-16	B1-S	60 cm 24"	< 64 cm < 25"	Blue
	72819-17	B2-L		> 64 cm > 25"	Blue

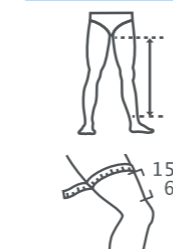

# Actimove® Genu Eco

## Knee Immobilizer

**Comfortable Knee Immobilizer with an anatomically pre-shaped posterior stay for an enhanced fit**

- Helps to relieve pain by immobilizing the knee through the pre-shaped posterior stay and the repositionable lateral stays.
- Individual immobilization through adjustable lateral stays.
- Enhanced fit through the anatomically pre-shaped posterior stay.
- Quick individual fit, easy application and removal thanks to the convenient hook-and-loop system.
- Comfortable wear thanks to the lightweight, slim design.
- Enhanced patient comfort through cushioning foam material covered with terry cloth liner.
- Suitable for those sensitive to latex, as this product is not made with natural rubber latex.
- For better hygiene, after removal of aluminum stays, product or part of the product is machine washable. Always read the washing instructions on the packaging.



**This product is intended to stabilize/immobilize the knee.**

**Fields of application include:**

- Post-operative knee support (e.g., after ligament repairs)
- Post-traumatic knee conditions (e.g., meniscal injuries, patella luxation)
- Post-arthroscopic treatment

	Ref.	Size	Measurements		Color
			Body Height	Above Knee	
	72819-08	A1-S	140 - 160 cm 4' 7" - 5' 3"	<52 cm <20 <sup>1</sup> / <sub>2</sub> "	Blue
	72819-09	A2-L		52 - 65 cm 20 <sup>1</sup> / <sub>2</sub> " - 25 <sup>1</sup> / <sub>2</sub> "	Blue
	72819-10	B1-S	160 - 180 cm 5' 3" - 5' 10"	<52 cm <20 <sup>1</sup> / <sub>2</sub> "	Blue
	72819-11	B2-L		52 - 65 cm 20 <sup>1</sup> / <sub>2</sub> " - 25 <sup>1</sup> / <sub>2</sub> "	Blue
	72819-12	C1-S	>180 cm >5' 10"	<52 cm <20 <sup>1</sup> / <sub>2</sub> "	Blue
	72819-13	C2-L		52 - 65 cm 20 <sup>1</sup> / <sub>2</sub> " - 25 <sup>1</sup> / <sub>2</sub> "	Blue

### Extension Tabs for Thigh or Calf

	Ref.	Size	Clips	Color	Unit
	72819-74	S	A1 - A2	Blue	10
	72819-75	M	B1 - B2	Blue	10
	72819-76	L	C1 - C2	Blue	10

ANKLE



# Actimove® TaloMotion

## Ankle Support

Anatomically shaped ankle support featuring 3D knitting technology and award-winning Helix design for gradient medical compression, providing stability, and integrated pressure pads to help pain relief

- Helps pain relief, as the support offers stability through the anatomical shape and the 3D flat-knitted structure, providing gradient medical compression.
- Contributes to healing by reducing edema, helping to relieve pain through targeted pressure and an intermittent massage effect thanks to the two anatomically shaped medial and lateral pressure pads.
- For more wearing comfort especially designed soft Motion-Comfort-Zone for a smooth fit in the instep.
- Anti-slip for pressure-reduced distal and proximal cuffs without an elastic band preventing constriction.
- Easier application thanks to the included donning aid.
- Seamless look thanks to the fusion technology used for the integration of the pressure pads.
- For long lasting wear, the heel and sole area is reinforced and strengthened by a special knitting structure to help prevent material abrasion.
- Skin-friendly and breathable 3D knit using OEKO-TEX® certified combination of yarn materials.<sup>1</sup>
- Suitable for those sensitive to latex, as this product is not made with natural rubber latex.
- Available in six sizes.
- For stock keeping, long shelf life of five years.
- For better hygiene, product or part of the product is machine washable. Always read the washing instructions on the packaging.

This product is intended for ankle support.

Fields of application include:

- Acute lateral ligament injury (ruptured ligaments in ankle joint)
- Acute ankle sprain
- Acute chronic and inflammatory edema (e.g., in arthrosis or arthritis)
- Chronic ankle instability
- Postoperative use
- Posttraumatic irritation (e.g., after distortions)



Donning Aid included.

	Ref.		Size	Measurements	Color	Unit
	Left	Right				
	73487-42	73487-12	XS	17 - 19 cm 6 <sup>1</sup> / <sub>2</sub> " - 7 <sup>1</sup> / <sub>2</sub> "	White	1
	73487-43	73487-13	S	19 - 21 cm 7 <sup>1</sup> / <sub>2</sub> " - 8 <sup>1</sup> / <sub>4</sub> "	White	1
	73487-44	73487-14	M	21 - 23 cm 8 <sup>1</sup> / <sub>4</sub> " - 9"	White	1
	73487-45	73487-15	L	23 - 25 cm 9" - 9 <sup>3</sup> / <sub>4</sub> "	White	1
	73487-46	73487-16	XL	25 - 27 cm 9 <sup>3</sup> / <sub>4</sub> " - 10 <sup>1</sup> / <sub>2</sub> "	White	1

<sup>1</sup> Tested for harmful substances according to OEKO-TEX® Standard 100. OEKO-TEX® certificate: 13.HTR.25112

# Actimove® Standard Walker

## Ankle Walker

### A lighter walker with circumferential strapping for increased stability

- Designed to stabilize and protect the lower leg, ankle, and foot.
- For added walking confidence, reliably slip resistant on most surfaces, thanks to the robust profile sole.
- High patient comfort thanks to the lightweight design of the walker.
- For more wearing comfort, at least 20% lighter than previous version.
- Stability through conforming plastic uprights restricting motion of the leg.
- Stability due to the non-slip circumferential strapping.
- Improved comfort through minimized impact thanks to the shock absorbing inner sole.
- Promotes natural gait due to a well-balanced rocker sole.
- Walking comfort and support thanks to the dense foam lining.
- Available in High (knee-height) or Low (ankle-height).
- Available in five sizes.
- For stock keeping, long shelf life of five years.
- For better hygiene, product or part of the product is hand washable. Always read the washing instructions on the packaging.



Optional Heel Wedge.

The product is designed to stabilize and protect the lower leg, ankle and foot.

Fields of application include:

- Stabilization of fractures of the foot and ankle
- Soft tissue injuries of the lower extremity
- Severe ankle sprains
- Stress fractures of the lower leg
- Postoperative rehabilitation and trauma

Ref.	Size	Shoe Sizes		Color	Unit
		Male	Female		
76270-50	XS - Low	UK < 3.5	UK < 3.5	Black	1
76270-51	S - Low	UK 4 - 6.5	UK 4 - 6.5	Black	1
76270-52	M - Low	UK 7 - 9.5	UK 7 - 9.5	Black	1
76270-53	L - Low	UK 10 - 12	UK 10 - 12	Black	1
76270-54	XL - Low	UK > 12	UK > 12	Black	1
76270-55	XS - High	UK < 3.5	UK < 3.5	Black	1
76270-56	S - High	UK 4 - 6.5	UK 4 - 6.5	Black	1
76270-57	M - High	UK 7 - 9.5	UK 7 - 9.5	Black	1
76270-58	L - High	UK 10 - 12	UK 10 - 12	Black	1
76270-59	XL - High	UK > 12	UK > 12	Black	1
76277-96	UNIVERSAL	Actimove Heel Wedges For Walker		Black	1 Heel Wedge

# Actimove® Standard Air Walker

## Ankle Walker

### A lighter walker with easily adjustable air bladders to help control swelling, with circumferential strapping for increased stability

- Designed to stabilize and protect the lower leg, ankle, and foot.
- Helps to control swelling and ensures a snug fit as medial and lateral air bladders create a large surface for contact pressure.
- For added walking confidence, reliably slip resistant on most surfaces, thanks to the robust profile sole.
- High patient comfort thanks to the lightweight design of the walker.
- For more wearing comfort, at least 20% lighter than previous version.
- Individual and easily adjustable compression level thanks to the integrated pump and valve system.
- Stability through conforming plastic uprights restricting motion of the leg.
- Stability due to the non-slip circumferential strapping.
- Improved comfort through minimized impact thanks to the shock absorbing inner sole.
- Promotes natural gait due to a well-balanced rocker sole.
- Walking comfort and support thanks to the dense foam lining.
- Available in High (knee-height) or Low (ankle-height).
- Available in five sizes.
- For stock keeping, long shelf life of five years
- For better hygiene, product or part of the product is hand washable. Always read the washing instructions on the packaging.



The product is designed to stabilize and protect the lower leg, ankle and foot.

Fields of application include:

- Stabilization of fractures of the foot and ankle
- Soft tissue injuries of the lower extremity
- Severe ankle sprains
- Stress fractures of the lower leg
- Postoperative rehabilitation and trauma

Ref.	Size	Shoe Sizes		Color	Unit
		Male	Female		
76272-50	XS - Low	UK < 3.5	UK < 3.5	Black	1
76272-51	S - Low	UK 4 - 6.5	UK 4 - 6.5	Black	1
76272-52	M - Low	UK 7 - 9.5	UK 7 - 9.5	Black	1
76272-53	L - Low	UK 10 - 12	UK 10 - 12	Black	1
76272-54	XL - Low	UK > 12	UK > 12	Black	1
76272-55	XS - High	UK < 3.5	UK < 3.5	Black	1
76272-56	S - High	UK 4 - 6.5	UK 4 - 6.5	Black	1
76272-57	M - High	UK 7 - 9.5	UK 7 - 9.5	Black	1
76272-58	L - High	UK 10 - 12	UK 10 - 12	Black	1
76272-59	XL - High	UK > 12	UK > 12	Black	1

FOOT



## Actimove® Offloading Shoe

**Wide base for extra stability and extended sole in the front area for impact protection.**

- Patients can feel safe while walking due to the non-slip sole.
- Easy to apply and remove.
- Protects the cast from water as the shoe is water resistant.
- Good standing and safe walking, as the weight is shifted to the back of the foot through the 15° dorsal flexion.
- Provides impact protection especially after foot surgery thanks to the extended sole at the front.
- Extra stability thanks to the wide base.
- Lightweight.
- Suitable for those sensitive to latex, as this product is not made with natural rubber latex.
- For stock keeping, wearable or usable on either left or right foot.

The product is designed for relief and protection of the forefoot following surgery.

Fields of application include:

- Post-surgical healing
- Wounds or ulcerations
- Any situation that requires a pressure off-load of the forefoot
- Forefoot trauma



Ref.	Size	Shoe Size		Color	Unit
		EU	UK		
65004-20	XS	31 - 34	12 - 2	Black	1
65004-21	S	35 - 38	3 - 5.5	Black	1
65004-22	M	39 - 41	6.5 - 7.5	Black	1
65004-23	L	42 - 43	8 - 8.5	Black	1
65004-24	XL	44 - 47	10 - 12.5	Black	1

## Actimove® Cast Shoe Rocker Sole

Rocker Sole Shoe

**The rocker sole helps ease pressure when ambulating and allows an easy roll through the gait pattern.**

- Patients can feel safe while walking due to the non-slip sole.
- Easy to apply and remove.
- Protects the cast from water as the shoe is water resistant.
- Lightweight.
- Suitable for those sensitive to latex, as this product is not made with natural rubber latex.
- For stock keeping, wearable or usable on either left or right foot.

The product is a multi-use cast boot designed to protect casts of all types. The cast shoe fits right or left and accommodates bulky bandages.

Fields of application include:

- Fracture and cast shoe
- Postoperative healing



Ref.	Size	Shoe Size			Color	Unit
		EU	US	UK		
65004-81	XS	31 - 34	1 - 3	12 - 2	Black	1
65004-82	S	35 - 38	3.5 - 6	3 - 5.5	Black	1
65004-83	M	39 - 41	6 - 8	6.5 - 7.5	Black	1
65004-84	L	42 - 43	9 - 10	8 - 8.5	Black	1
65004-85	XL	44 - 47	11 - 14	10 - 12.5	Black	1

# Actimove® Open Toe Shoe

## Post-OP Shoe

**Water-resistant open-toe post-op shoe that provides the foot with solid protection and accommodates bulky bandages with ease.**

- Provides the foot with solid protection and accommodates bulky bandage with ease.
- Patients can feel safe while walking due to the non-slip sole.
- Easy to apply and remove.
- Protects the cast from water as the shoe is water resistant.
- Lightweight.
- Suitable for those sensitive to latex, as this product is not made with natural rubber latex.
- For stock keeping, wearable or usable on either left or right foot.

**The product is designed to provide the foot with solid protection.**

### Fields of application include:

- Water-resistant open-toe post-op shoe for safe walking and solid protection with bulky bandages.
- Postoperative for stabilization
- Postoperative healing
- Trauma care
- Support and protection for metatarsal stress fractures and broken toes



Ref.	Size	Shoe Size			Color
		EU	US	UK	
65004-44	XS	37 - 38.5	5 - 6.5	4.5 - 5.5	Black
65004-45	S	39 - 41	6.5 - 8	6 - 7.5	Black
65004-46	M	41.5 - 43	8.5 - 10	8 - 9.5	Black
65004-47	L	43.5 - 45	10.5 - 12	9.5 - 11	Black
65004-48	XL	45.5 - 47	12.5 - 14	11.5 - 12.5	Black

CERVICAL



# Actimove® Cervical

## Cervical Collar Medium Density

### Medium-density cervical support, with a removable, washable sleeve

- Provides comfortable head and neck support through the medium density core, restricting neck range of motion.
- Support of the cervical spine after circular application.
- Holds the head in a stable position thanks to the pre-formed anatomical shape.
- Reliable support due to the durable materials.
- Good patient comfort due to the soft foam cover.
- Easy to apply and adjust hook and loop closures.
- Suits most patients due to the variety in neck sizes covered.
- Suitable for those sensitive to latex, as this product is not made with natural rubber latex.
- For extra hygiene and to keep the collar clean, the removable sleeve can be machine washed at 30 °C / 85 °F.
- Available in five sizes, XL available in two heights.
- Shelf life of three years.
- For better hygiene, product or part of the product is machine washable. Always read the washing instructions on the packaging.

The product is intended to provide support/stabilization to the cervical area.

#### Fields of application include:

- Short-term use after whiplash
- Degenerative changes in the cervical area (e.g., osteochondrosis, spondylarthroses, minor cervical arthrosis)
- Cervical migraine
- Sprains
- Strains
- Acute and chronic painful cervical syndrome
- Muscular pain syndrome
- Minor cervical trauma
- Immediate treatment of acute cervical fractures
- Postoperative use



	Ref.	Size	Measurements		Color	Unit
			Circumference	Height		
	72819-25	XS	26 – 33 cm 10" – 13"	6.5 cm 2 <sup>1</sup> / <sub>2</sub> "	White	1
	72819-26	S	30 – 36 cm 11 <sup>3</sup> / <sub>4</sub> " – 14"	7.5 cm 3"	White	1
	72819-27	M	33 – 39 cm 13" – 15 <sup>1</sup> / <sub>4</sub> "	9 cm 3 <sup>1</sup> / <sub>2</sub> "	White	1
	72819-28	L	36 – 42 cm 14" – 16 <sup>1</sup> / <sub>2</sub> "	10 cm 4"	White	1
	72819-29	XL	39 – 45 cm 15 <sup>1</sup> / <sub>4</sub> " – 17 <sup>3</sup> / <sub>4</sub> "	11 cm 4 <sup>1</sup> / <sub>4</sub> "	White	1
	72819-30	XL-SHORT	38 – 48 cm 15" – 19"	7 cm 2 <sup>3</sup> / <sub>4</sub> "	White	1

# Actimove® Vertebrace

## Cervical Collar

**Ready-to-use cervical collar for acute and emergency care with slim profile that stacks flat for efficient storage**

- Ready-to-use in acute and emergency care for immobilization of the cervical spine, giving rigid support for the head, chin and the base of the skull.
- Suitable for emergency care as large anterior opening allows access to the neck for cricothyrotomy or tracheostomy.
- Quick application in seated or supine position thanks to the one piece construction that easily snaps into shape.
- Efficient storage thanks to the slim profile that stacks flat.
- Fast and easy to close thanks to the wide hook-and-loop closure system.
- Patient comfort through lightweight design with soft foam padding.
- Clear size selection thanks to the color-coding of the closure.
- For imaging diagnostics, product is radiolucent and free from metal.

**This product is to provide stabilization of the neck.**

**Fields of application include:**

- Postoperative use
- Short term use after whiplash injury
- Spondylarthrosis deformans (deteriorative illness of vertebral joints)
- Distortions (sprains)
- Strains
- Acute and chronic painful cervical syndrome
- Acute and emergency care



	Ref.	Size	Measurements		Color
			Height	Length	
	79301-00	XS (X)	8 cm 3"	57 cm 22 <sup>1</sup> / <sub>2</sub> "	Green
	79302-00	S	9 cm 3 <sup>1</sup> / <sub>2</sub> "	57 cm 22 <sup>1</sup> / <sub>2</sub> "	Yellow
	79303-00	M (R)	11 cm 4 <sup>1</sup> / <sub>4</sub> "	57 cm 22 <sup>1</sup> / <sub>2</sub> "	Orange
	79304-00	L (T)	12 cm 4 <sup>3</sup> / <sub>4</sub> "	57 cm 22 <sup>1</sup> / <sub>2</sub> "	Navy

## KIDS ASSORTEMENT

# Choose the right product for your patients.

Actimove is dedicated to supporting the needs of pediatric patients with an assortment of solutions that focus on both functionality and comfort.

Our range includes high-quality braces and supports tailored to the unique needs of children, helping your younger patients maintain their mobility and well-being during treatment and rehabilitation.

### Actimove® KIDS Especially for kids



- Aids pain relief after acute injuries after play and sports
- Designed for children
- Includes products with COOLMAX® AIR Technology
- Neoprene-free, suitable for those sensitive to latex, as this product is not made with natural rubber latex.

### Actimove® PROFESSIONAL LINE Excellent functionality for pain relief



- Physician recommended or prescribed
- For professional treatment of acute injuries, post-op use and rehabilitation of chronic orthopedic issues
- Pain relief from functional design based on biomechanics
- Control and guide joint movement
- Support – Stabilize – Immobilize

## Actimove® KIDS

Many children suffering from play or sport injuries may not like to wear supports, because most available neoprene made options may be too hot.

Actimove® Kids offers pain relief and healing through balanced warmth and medical compression. Kids will enjoy great comfort from skin-friendly materials offering excellent moisture management.

- Made with **COOLMAX® AIR<sup>1</sup>** technology, Actimove® Kids are engineered for quick drying and exceptional breathability to keep children cool and dry.
- The perforated **performance material** of Actimove® Kids is neoprene-free, friendly to the skin, and suitable for those sensitive to latex, as this product is not made with natural rubber latex.
- Furthermore, **medical compression** properties for support and stability help reduce swelling and manage pain relief.



<sup>1</sup> COOLMAX® AIR is a trademark of The LYCRA company

# Actimove® Wrist Stabilizer

Removable Metal Stay, Left or Right Hand

**Anatomically shaped stay for secure stabilization, managing sprains and strains**

- Pain relief and healing are supported through balanced warmth and medical compression.
- For comfort, lining made of special premium soft material.
- Comfort and good breathability through neoprene-free performance material.
- Stabilizes wrist through an anatomically shaped removable stay for left and right hand application.
- Quick and easy to fit with slip-on design and individually adjustable straps.
- Special comfort in a premium soft material and seamless design.
- Can be easily worn under clothing due to low profile.
- Suitable for those sensitive to latex, as this product is not made with natural rubber latex.
- Pediatric sizes, ages 2-7.
- For stock keeping, long shelf life of five years.
- For better hygiene, product or part of the product is hand washable. Always read the washing instructions on the packaging.

This product is intended to provide support/stabilization to the wrist.

Fields of application include:

- Tendonitis
- Sprains, strains, soft tissue injuries
- Post-operative care
- After cast removal

Slip-On Design



Ref.	Size	Measurements	Color
75729-30	Pediatric	4 <sup>1/2</sup> " - 5 <sup>1/2</sup> " / 11.5 - 14 cm	Black



# Actimove® Mitella

Arm Sling

**Colorful support for children**

- Child-friendly designed shoulder, elbow and arm support limiting their range of motion with a rested, flexed elbow position.
- Helps to relieve pain by stabilizing the shoulder joint and keeping the flexed elbow in a pocket which limits the range of motion.
- Comfortable fit around the neck.
- Patient comfort thanks to the breathable pocket material.
- Appealing and child-friendly, unique, playful pocket design.
- Convenient for follow up exams, as product does not to be removed prior to taking x-rays.
- Protects casts or bandaging from moisture and dirt through the pocket.
- Suitable for those sensitive to latex, as this product is not made with natural rubber latex.
- Available in a universal, pediatric size.
- For stock keeping, long shelf life of five years.
- For better hygiene, product or part of the product is machine washable. Always read the washing instructions on the packaging.

The product is intended to provide support to the arm, elbow and shoulder.

Fields of application include:

- Postoperative use (e.g., after rotator cuff rupture)
- Fracture management (e.g., clavicle, scapular, humeral, and greater tuberosity fractures)
- Joint distortions (sprains) and dislocations (e.g., acromioclavicular & sternoclavicular dislocations, shoulder luxation)
- Inflammatory diseases (e.g., calcific tendinitis of the rotator cuff)
- Minor instability of the shoulder (e.g., dorsal instability)
- Support for hemiplegic patients
- Support while wearing a cast or splint
- Temporary arm stabilization in emergency/paramedic care



Ref.	Size	Measurements	Color
74561-13	Pediatric	27 - 34 cm / 10 <sup>1/2</sup> " - 13 <sup>1/2</sup> "	Navy



# Actimove® Sling

## Arm Sling – On a Roll

### Customizable arm sling for multi-application in a child-friendly, playful design

- Provides support to the arm, elbow and shoulder by securely holding the forearm in a flexed position.
- Stabilization and relief of the shoulder through movement limitation.
- Customizable support for multiple applications.
- Brighten kids' spirits with the child-friendly, playful design.
- Comfortable to wear thanks to the soft foam material.
- Quick and easy to apply or remove thanks to the hook-an-loop closure system with Y-tabs.
- Suitable for those sensitive to latex, as this product is not made with natural rubber latex.
- For better hygiene, product or part of the product is machine washable. Always read the washing instructions on the packaging.
- For stock keeping, long shelf life of five years.

**This product is intended to provide support to the arm, elbow and shoulder.**

#### Fields of application include:

- Postoperative use (e.g. after rotator cuff rupture)
- Fracture management (e.g. clavicle, scapular, humeral, and greater tuberosity fractures)
- Joint distortions (sprains) and dislocations (e.g. acromioclavicular & sternoclavicular dislocations, shoulder luxation)
- Inflammatory diseases (e.g. calcific tendinitis of the rotator cuff)
- Minor instability of the shoulder (e.g. dorsal instability)
- Support for hemiplegic patients
- Support while wearing a cast or splint
- Temporary arm stabilization in emergency/paramedic care



Ref.	Size	Measurements	Color
73117-00	Universal	3.6 cm x 10.8 m 1 <sup>2</sup> / <sub>5</sub> " x 11 <sup>4</sup> / <sub>5</sub> yds	Blue

## Actimove® PROFESSIONAL LINE – KIDS ASSORTMENT

The Actimove Professional Line also comprises solutions for your pediatric patients, supporting the treatment of acute injuries, post-op use and rehabilitation of chronic, orthopedic issues.

### Pain Relief

Actimove Professional Line products provide the right functionality based on biomechanics to help support patients' pain relief.

### Quality

Actimove Professional Line products are tested thoroughly and constantly updated for a high standard of quality and longevity.

### Comfort

Well-fitting products made from carefully chosen materials, paired with the correct sizing ensure patient comfort when it is most needed.

Actimove pledges to improve its offering further and further through research and innovation. All to give you assurance and help manage your patients' pain and support their movement.



# Actimove® Vertebrae

## Cervical Collar

Ready-to-use cervical collar for acute and emergency care with slim profile that stacks flat for efficient storage



- Ready-to-use in acute and emergency care for immobilization of the cervical spine, giving rigid support for the head, chin and the base of the skull.
- Suitable for emergency care as large anterior opening allows access to the neck for cricothyrotomy or tracheostomy.
- Quick application in seated or supine position thanks to the one piece construction that easily snaps into shape.
- Efficient storage thanks to the slim profile that stacks flat.
- Fast and easy to close thanks to the wide hook-and-loop closure system.
- Patient comfort through lightweight design with soft foam padding.
- Clear size selection thanks to the color-coding of the closure.
- For imaging diagnostics, product is radiolucent and free from metal.



This product is to provide stabilization of the neck.

Fields of application include:

- Postoperative use
- Short term use after whiplash injury
- Spondylarthrosis deformans (deteriorative illness of vertebral joints)
- Distortions (sprains)
- Strains
- Acute and chronic painful cervical syndrome
- Acute and emergency care

	Ref.	Size	Measurements		Color
			Height	Length	
	79300-00	PS 	7 cm 2 3/4"	43 cm 17"	Light Blue
	79305-00	P 	9 cm 3 1/2"	45 cm 17 3/4"	Red

# Actimove® Cast Shoe Rocker Sole

## Rocker Sole Shoe

The rocker sole helps ease pressure when ambulating and allows an easy roll through the gait pattern.

- Patients can feel safe while walking due to the non-slip sole.
- Easy to apply and remove.
- Protects the cast from water as the shoe is water resistant.
- Lightweight.
- Suitable for those sensitive to latex, as this product is not made with natural rubber latex.
- For stock keeping, wearable or usable on either left or right foot.

The product is a multi-use cast boot designed to protect casts of all types. The cast shoe fits right or left and accommodates bulky bandages.

Fields of application include:

- Fracture and cast shoe
- Postoperative healing



Ref.	Size	Measurements			Color	Unit
		EU	US	UK		
65004-80	Pediatric Infant	25 - 30	8.5 - 12	8 - 11.5	Black	1



Always read the label and  
follow the directions for use

ESS0449  
11/2021

[www.actimove.com.au](http://www.actimove.com.au)

[www.deltacast.com.au](http://www.deltacast.com.au)

**BSN medical Australia & New Zealand  
an Essity company**

L6, 211 Wellington Road,  
Mulgrave, Victoria Australia 3170  
PO Box 337, Mount Waverley, Victoria 3149

**Customer Service Australia**  
T 1300 276 633 F 1300 998 830  
[www.bsnmedical.com.au](http://www.bsnmedical.com.au)

**Customer Service New Zealand**  
T 0508 276 111 F 0508 998 830  
[www.bsnmedical.co.nz](http://www.bsnmedical.co.nz)